



Operator's Manual

Serial Number Range

GRTM-12
GRTM-15
GRTM-20

from GRP-60000
from GRR-10001

CE
PK

with
Maintenance
Information

Original Instructions
Seventh Edition
Second Printing
Part No. 1297725GT

Manufacturer:

Terex Global GmbH
Bleicheplatz 2
Schaffhausen, 8200
Switzerland

EU Authorized representative:

Genie Industries B.V.
Boekerman 5
4751 XK OUD GASTEL
The Netherlands

UK Authorized representative:

Genie UK Limited
The Maltings
Wharf Road
Grantham
NG31 6BH
UK

Contents

Introduction	1
Symbol and Hazard Pictorials Definitions	5
General Safety	7
Personal Safety.....	10
Work Area Safety.....	11
Legend	18
Controls.....	19
Inspections.....	22
Operating Instructions.....	34
Transport and Lifting Instructions	44
Maintenance	49
Specifications.....	51

Copyright © 2000 Terex Corporation

Seventh Edition: Second Printing, November 2022

Genie is a registered trademark of Terex South Dakota, Inc. in the U.S.A. and many other countries.

“GS” is a trademark of Terex South Dakota, Inc.

 Complies with EC Directive 2006/42/EC
See EC Declaration of Conformity

 Supply of Machinery (Safety) Regulations 2008



Introduction

About this manual

Genie appreciates your choice of our machine for your application. Our number one priority is user safety, which is best achieved by our joint efforts. This book is an operation and daily maintenance manual for the user or operator of a Genie machine.

This manual should be considered a permanent part of your machine and should remain with the machine at all times. If you have any questions, contact Genie.

Product Identification

The machine serial number is located on the serial label.

Serial number stamped on chassis

Serial label located on chassis

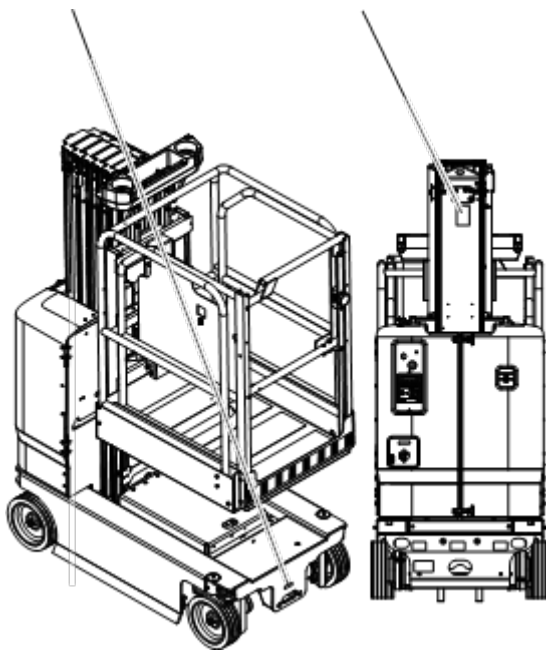

Intended Use and Familiarization Guide

The intended use of this machine is to lift personnel, including tools, and materials to an aerial work site. Before operating the machine, it's the operator's responsibility to read and understand this familiarization guide.

- Each person must be trained to operate a Mobile Elevating Work Platform (MEWP).
- Familiarization with the MEWP must be given to each person who is authorized, competent and trained.
- Only trained and authorized personnel should be permitted to operate the machine.
- The operator is responsible to read, understand, and obey the manufacturer's instructions and safety rules provided in the Operator's Manual.
- The Operator's Manual is located in the manual storage container, at the platform.
- For specific product applications, see **Contacting The Manufacturer**.

Introduction

Platform controls symbology and related machine movement:



Lift function enable button



Drive function enable button



Platform up/down (when lift function selected)



Drive forward/reverse (when drive function selected)



Steer right/left (when drive function selected)



Area of operation, indoor use button



Area of operation, outdoor use button

Ground controls symbology and related machine movement:



Lift function enable button



Platform up/down button

Sequential functions and movement:

- Drive and steer.

Interlocked functions:

- Elevated drive speed.
- Elevated drive in an off-level condition.
- All platform and ground controls.

Limitations of use:

- The intended use of this machine is to lift personnel, including tools, and materials to an aerial work site.
- Do not elevate the platform unless the machine is on firm level ground.

Introduction

Bulletin Distribution and Compliance

Safety of product users is of paramount importance to Genie. Various bulletins are used by Genie to communicate important safety and product information to dealers and machine owners.

The information contained in the bulletins is tied to specific machines using the machine model and serial number.

Distribution of bulletins is based on the most current owner on record along with their associated dealer, so it is important to register your machine and keep your contact information up to date.

To ensure safety of personnel and the reliable continued operation of your machine, be sure to comply with the action indicated in a respective bulletin.

To view any open bulletins for your machine, visit us on the web at www.genielift.com.

Contacting the Manufacturer

At times it may be necessary to contact Genie. When you do, be ready to supply the model number and serial number of your machine, along with your name and contact information. At minimum, Genie should be contacted for:

Accident reporting

Questions regarding product applications and safety

Standards and regulatory compliance information

Current owner updates, such as changes in machine ownership or changes in your contact information. See Transfer of Ownership, below.

Transfer of Machine Ownership

Taking a few minutes to update owner information will ensure that you receive important safety, maintenance and operating information that applies to your machine.

Please register your machine by visiting us on the web at www.genielift.com or by calling us toll free at 1-800-536-1800.

Introduction



Danger

Failure to obey the instructions and safety rules in this manual will result in death or serious injury.

Do Not Operate Unless:

- You learn and practice the principles of safe machine operation contained in this operator's manual.
 - 1 Avoid hazardous situations.**

Know and understand the safety rules before going on to the next section.

 - 2 Always perform a pre-operation inspection.
 - 3 Always perform function tests prior to use.
 - 4 Inspect the workplace.
 - 5 Only use the machine as it was intended.
- You read, understand and obey the manufacturer's instructions and safety rules—safety and operator's manuals and machine decals.
- You read, understand and obey employer's safety rules and worksite regulations.
- You read, understand and obey all applicable governmental regulations.
- You are properly trained to safely operate the machine.

Safety Sign Maintenance

Replace any missing or damaged safety signs. Keep operator safety in mind at all times. Use mild soap and water to clean safety signs. Do not use solvent-based cleaners because they may damage the safety sign material.

Hazard Classification

Decals on this machine use symbols, color coding, and signal words to identify the following:



Safety alert symbol—used to alert you to potential personal injury hazards. Obey all safety messages that follow this symbol to avoid possible injury or death.



Indicates a hazardous situation which, if not avoided, will result in death or serious injury.



Indicates a hazardous situation which, if not avoided, could result in death or serious injury.



















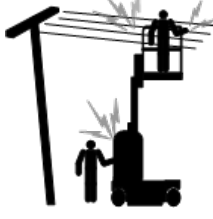

Indicates a hazardous situation which, if not avoided, could result in minor or moderate injury.

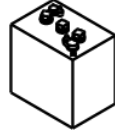











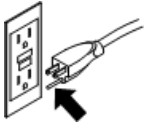
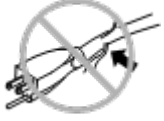

Indicates a property damage message.

Symbol and Hazard Pictorials Definitions

				
Read the operator's manual	Read the service manual	Crush hazard	No smoking	Collision hazard
				
Collision hazard	Tip-over hazard	Tip-over hazard	Electrocution hazard	Electrocution hazard
				
Burn hazard	Explosion hazard	Fire hazard	Batteries used as counterweights	Tiedown
				
Voltage rating for power to platform	Pressure rating for air line to platform	Keep away from moving parts	Move machine to level ground	Lifting and tie down instructions

Symbol and Hazard Pictorials Definitions

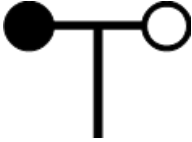
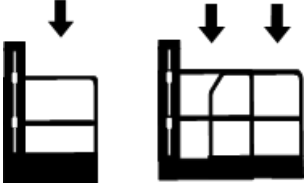
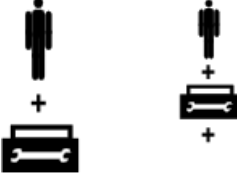
 <p>Maintain required clearance</p>	 <p>Access by trained and authorized personnel only</p>	 <p>Chock the wheels</p>	 <p>Release brakes</p>	 <p>Grounded AC 3-wire only</p>
 <p>Replace damaged wires and cords</p>	 <p>Wheel load</p>	 <p>Lanyard anchorage points</p>	 <p>Platform overloaded</p>	 <p>Manual force</p>
 <p>Lifting point</p>	 <p>Indoor</p>	 <p>Outdoor</p>	 <p>Auxiliary lowering</p>	 <p>Wind speed</p>
 <p>Maximum capacity</p>		 <p>Maximum capacity including occupant, tools, materials and options</p>		

General Safety

133147



1298467



82614



97899



82495



82481



133146

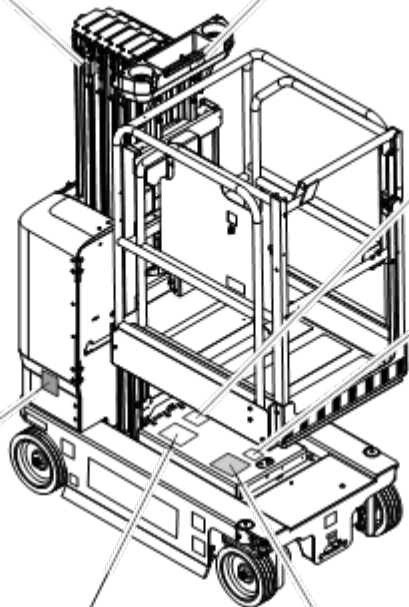

General Safety

114334

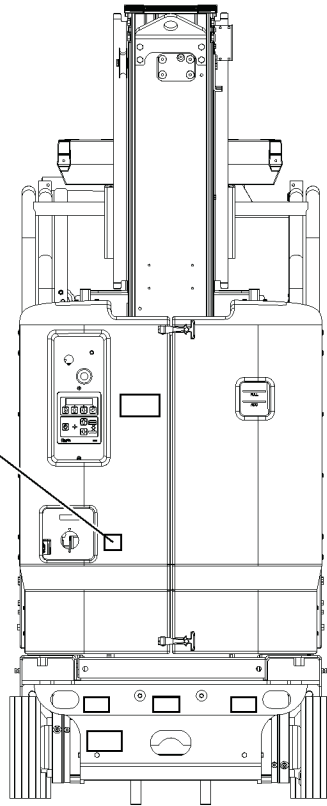

1263542

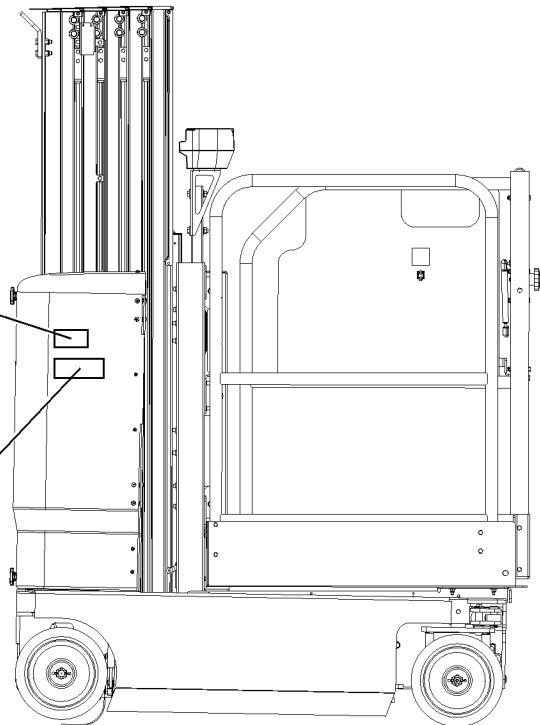

133015



General Safety

82487



114338

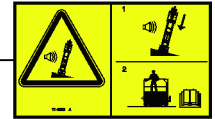

1294688



82487



1293166

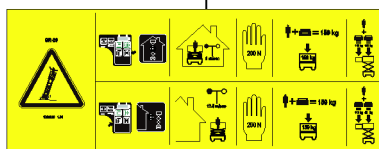

*1296620 GR-20

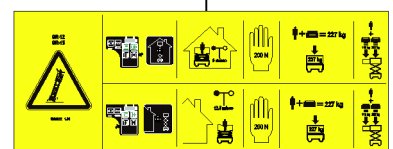

*1296622 GR-12 & GR-15

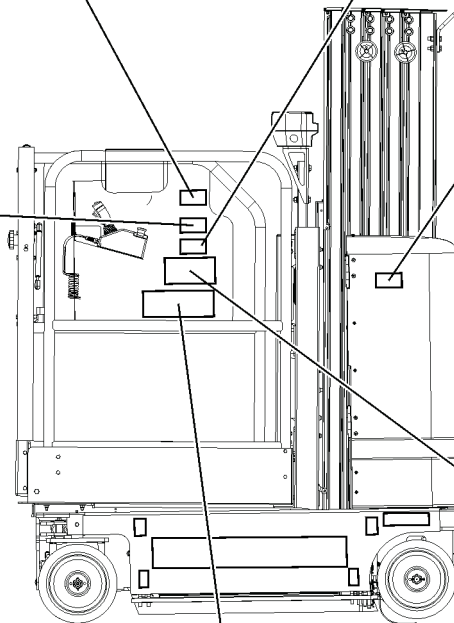

Personal Safety

Personal Fall Protection

Personal fall protection equipment (PFPE) is not required when operating this machine. If PFPE is required by job site or employer rules, the following shall apply:

All PFPE must comply with applicable governmental regulations and must be inspected and used in accordance with the manufacturer's instructions.

Work Area Safety

⚠ Electrocutation Hazards



This machine is not electrically insulated and will not provide protection from contact with or proximity to electrical current.



Obey all local and governmental regulations regarding required clearance from electrical power lines. At a minimum, the required clearance contained in the chart below must be followed.

Line Voltage	Required Clearance	
0 to 50KV	10 ft	3.05 m
50 to 200KV	15 ft	4.60 m
200 to 350KV	20 ft	6.10 m
350 to 500KV	25 ft	7.62 m
500 to 750KV	35 ft	10.67 m
750 to 1000KV	45 ft	13.72 m

Allow for platform movement, electrical line sway or sag, and beware of strong or gusty winds.

Keep away from the machine if it contacts energized power lines. Personnel on the ground or in the platform must not touch or operate the machine until energized power lines are shut off.

Do not operate the machine during lightning or storms.

Do not use the machine as a ground for welding.

⚠ Tip-over Hazards

Occupants, equipment and materials shall not exceed the maximum platform capacity or the maximum platform capacity of the platform extension. Weight in trays is part of the total platform load.

Maximum capacity - GR-12 and GR-15		
Standard platform		
Platform without extension	500 lbs	227 kg
Platform retracted	500 lbs	227 kg
Platform extended – Platform only	250 lbs	113 kg
Platform extended – Extension only	250 lbs	113 kg
Work tray station (option)	50 lbs	22 kg
Maximum occupants		1

500 lbs / 227 kg Extension only 250 lbs/113 kg Platform only 250 lbs/113 kg

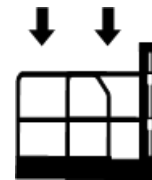

Work Area Safety

Maximum capacity - GR-20		
Standard platform		
Platform without extension	350 lbs	159kg
Platform retracted	350 lbs	159 kg
Platform extended – Platform only	100 lbs	45 kg
Platform extended – Extension only	250 lbs	113 kg
Work tray station (option)	50 lbs	22 kg
Maximum occupants	1	

350 lbs/159 kg



Extension only 250 lbs/113 kg Platform only 100 lbs/45 kg

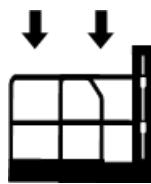

Do not raise the platform unless the machine is on a firm, level surface.



Do not depend on the tilt alarm as a level indicator. The tilt alarm sounds at the platform controls and the ground controls when the machine is on a severe slope.

If the tilt alarm sounds:

Lower the platform. Move the machine to a firm, level surface. If the tilt alarm sounds when the platform is raised, use extreme caution to lower the platform.

Do not drive over 0.5 mph / 0.8 km/h with the platform raised.

Do not raise the platform when wind speeds may exceed 28 mph / 12.5 m/s. If wind speeds exceed 28 mph / 12.5 m/s when the platform is raised, lower the platform and do not continue to operate the machine.

Outdoor use: Do not operate the machine outdoors with the indoor use button selected.



Do not operate the machine in strong or gusty winds. Do not increase the surface area of the platform or the load. Increasing the area exposed to the wind will decrease machine stability.



Use extreme care and slow speeds while driving the machine in the stowed position across uneven terrain, debris, unstable or slippery surfaces and near holes and drop-offs.

Work Area Safety

Do not drive the machine on or near uneven terrain, unstable surfaces or other hazardous conditions with the platform raised.

Do not use the machine as a crane.

Do not push the machine or other objects with the platform.

Do not contact adjacent structures with the platform.

Do not tie the platform to adjacent structures.

Do not place loads outside the platform perimeter. The work station tray is considered part of the platform.

Do not use the platform controls to free a platform that is caught, snagged, or otherwise prevented from normal motion by an adjacent structure. All personnel must be removed from the platform before attempting to free the platform using the ground controls.

Follow ratings for allowable manual force and number of occupants shown below.



Do not push off or pull toward any object outside of the platform.

Do not alter or disable the limit switches.

Do not alter or disable machine components that in any way affect safety and stability.

Do not replace items critical to machine stability with items of different weight or specification.

Do not use batteries that weigh less than the original equipment. Batteries are used as counterweight and are critical to machine stability. Each battery must weigh a minimum of 62 lbs/28 kg.

Do not modify or alter a mobile elevating work platform without prior written permission from the manufacturer. Mounting attachments for holding tools or other materials onto the platform, toeboards, or guard rail system can increase the weight in the platform and the surface area of the platform or the load.



Do not place or attach fixed or overhanging loads to any part of this machine.

Do not place ladders or scaffolds in the platform or against any part of this machine.



Do not transport tools and materials unless they are evenly distributed and can be safely handled by person(s) in the platform.

Maximum allowable manual force	Maximum occupants
45 lbs / 200 N	1

Work Area Safety



Do not use the machine on a moving or mobile surface or vehicle.

Be sure all tires are in good condition, castle nuts are properly tightened and cotter pins are properly installed.

⚠️ Crushing Hazard

Keep hands and limbs out of mast.

Do not work under the platform or mast without the battery cover raised.

Use common sense and planning when operating the machine with the controller from the ground. Maintain safe distances between the operator, the machine and fixed objects.

⚠️ Operation on Slopes Hazards

Do not drive the machine on a slope that exceeds the slope and side slope rating of the machine. Slope rating applies to machines in the stowed position.

Maximum slope rating, stowed position	30% (16.7°)
Maximum side slope rating, stowed position	30% (16.7°)

Note: Slope rating is subject to ground conditions with one person in the platform and adequate traction. Additional platform weight may reduce slope rating. See Driving on a Slope in the Operating Instructions section.

⚠️ Fall Hazards

The guard rail system provides fall protection. If occupant(s) of the platform are required to wear personal fall protection equipment (PFPE) due to job site or employer rules, PFPE and its use shall be in accordance with the PFPE manufacturer's instructions and applicable governmental requirements. Use approved lanyard attachment point provided.

Keep the platform floor clear of debris.

Close the entry gate before operating.



Do not sit, stand, or climb on the platform guard rails. Maintain a firm footing on the platform floor at all times.



Do not climb down from the platform when raised.

Do not enter or exit the platform unless the machine is in the stowed position.

Work Area Safety

⚠ Collision Hazards

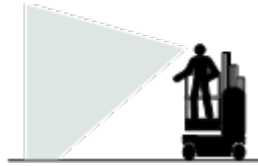

Be aware of limited sight distance and blind spots when driving or operating.

Be aware of extended platform position when moving the machine.

The machine must be on a level surface and wheels chocked or secured before releasing the brakes.

Operators must comply with employer, job site, and governmental rules regarding use of personal protective equipment.



Do not lower the platform unless the area below is clear of personnel and obstructions.



Limit travel speed according to the condition of the ground surface, congestion, slope, location of personnel, and any other factors which may cause collision.



Check the work area for overhead obstructions or other possible hazards.

Observe and use color-coded direction arrows on the platform controls and the platform decal plate for drive and steer functions.

Do not operate a machine in the path of any crane or moving overhead machinery unless the controls of the crane have been locked out and/or precautions have been taken to prevent any potential collision.



Be aware of crushing hazards when grasping the platform guard rail.

No stunt driving or horseplay while operating a machine.

Work Area Safety

▲ Bodily Injury Hazard

Do not operate the machine with a hydraulic oil or air leak. An air leak or hydraulic leak can penetrate and/or burn skin.

Improper contact with components under any cover will cause serious injury. Only trained maintenance personnel should access compartments. Access by the operator is only advised when performing a pre-operation inspection. All compartments must remain closed and secured during operation.

▲ Explosion and Fire Hazards

Do not operate the machine or charge the battery in hazardous locations or locations where potentially flammable or explosive gases or particles may be present.

▲ Damaged Machine Hazards

Do not use a damaged or malfunctioning machine.

Conduct a thorough pre-operation inspection of the machine and test all functions before each work shift. Immediately tag and remove from service a damaged or malfunctioning machine.

Be sure all maintenance has been performed as specified in this manual and the appropriate Genie service manual.

Be sure all decals are in place and legible.

Be sure the operator's manual is complete, legible, and in the storage container located on the machine.

▲ Component Damage Hazards

Do not use any battery charger greater than 24V to charge the batteries.

Do not use the machine as a ground for welding.

Work Area Safety

⚠ Battery Safety

Burn Hazards



Batteries contain acid. Always wear protective clothing and eye wear when working with batteries.

Avoid spilling or contacting battery acid. Neutralize battery acid spills with baking soda and water.

Do not expose the batteries or the charger to water or rain during charging.

Explosion Hazards



Keep sparks, flames, and lighted tobacco away from batteries. Batteries emit explosive gas.

The battery tray may remain open during the entire charging cycle.

Do not contact the battery terminals or the cable clamps with tools that may cause sparks.

Component Damage Hazard

Do not use any battery charger greater than 24V to charge the batteries.

Electrocution/Burn Hazards



Connect the battery charger to a grounded, AC 3-wire electrical outlet only.

Inspect daily for damaged cords, cables and wires. Replace damaged items before operating.

Avoid electrical shock from contact with battery terminals. Remove all rings, watches and other jewelry.

Tip-over Hazard

Do not use batteries that weigh less than the original equipment. Batteries are used as counterweight and are critical to machine stability. Each battery must weigh a minimum of 62 lbs/28 kg.

Lifting Hazard

Use the appropriate number of people and proper lifting techniques when lifting batteries.

Lockout After Each Use

- 1 Select a safe parking location—firm level surface, clear of obstruction and traffic.
- 2 Lower the platform.
- 3 Turn the key switch to the off position and remove the key to secure from unauthorized use.
- 4 Charge the batteries.

Legend

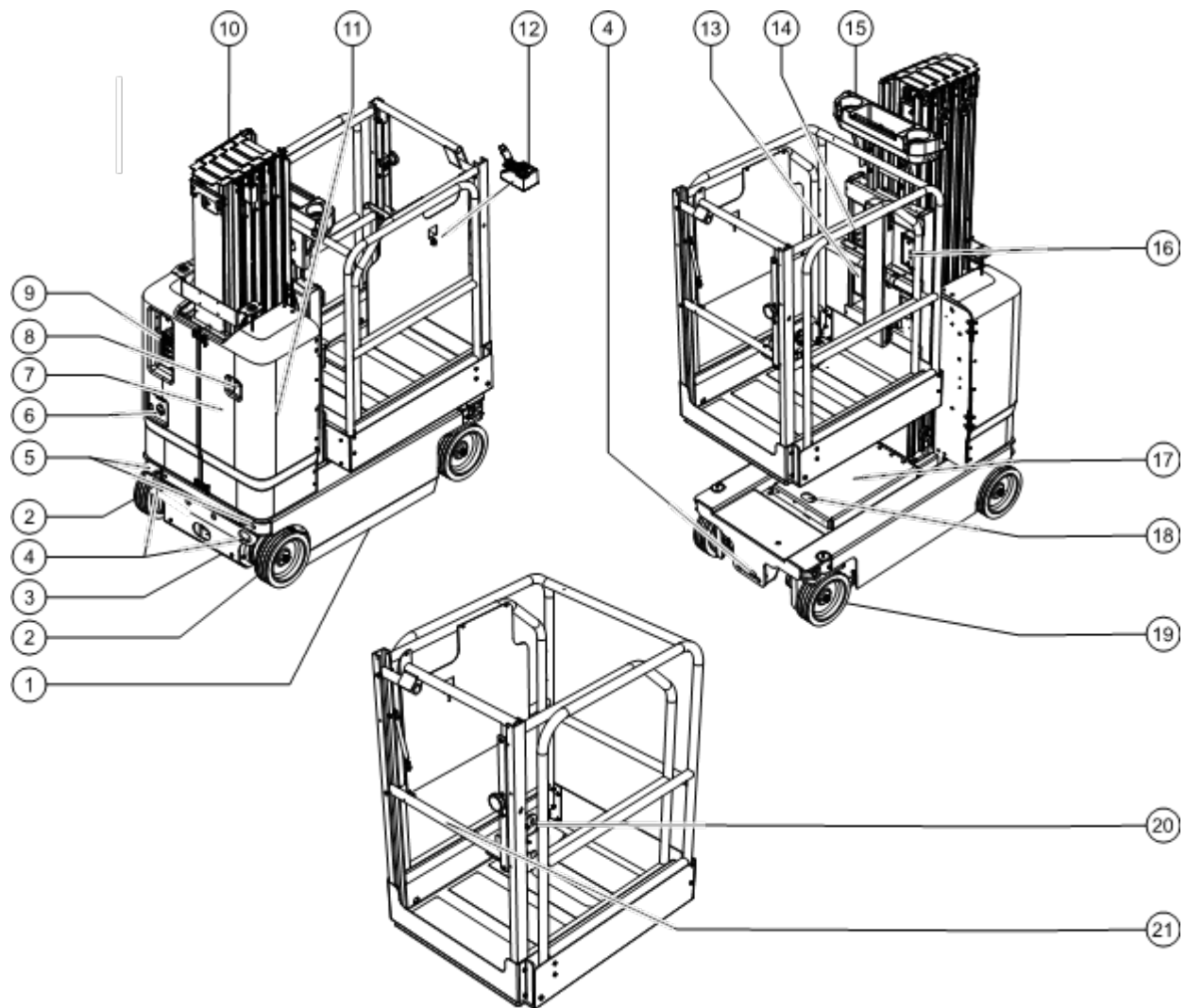

- | | | |
|---------------------------------|--|--|
| 1 Pothole guard | 9 Ground controls | 15 Tool Tray |
| 2 Non-steer tire | 10 Mast | 16 GFCI outlet |
| 3 Auxiliary lowering valve | 11 Brake release pump knob
(under covers) | 17 Battery compartment cover |
| 4 Transport tie-down | 12 Platform controls | 18 Battery cover latch |
| 5 Forklift pockets | 13 Manual storage container | 19 Steer tire |
| 6 Battery charger display | 14 Lanyard anchorage point | 20 Platform extension release
pedal |
| 7 Covers | | 21 Platform extension entry gate |
| 8 Hydraulic oil level indicator | | |

Controls

The ground control station is to be used as a means to raise the platform for function tests and for storage purposes. The ground control station can be used in the event of an emergency to rescue an incapacitated person in the platform.

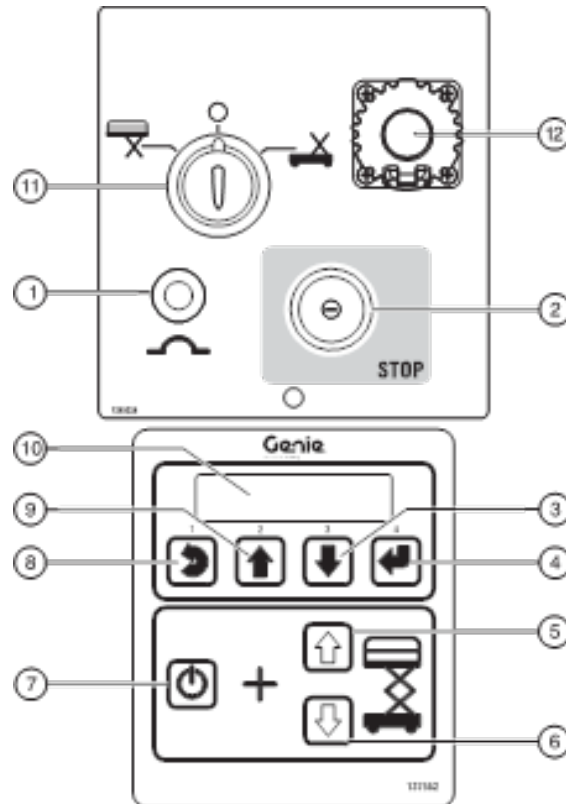

Ground Control Panel

- | | | | |
|---|---|----|--|
| 1 | 7A breaker for electrical circuits | 8 | Menu escape button |
| 2 | Red Emergency Stop button
Push in the red Emergency Stop button to the off position to stop all functions. Pull out the red Emergency Stop button to the on position to operate the machine. | 9 | Menu up button |
| 3 | Menu down button | 10 | LCD diagnostic readout |
| 4 | Menu enter button | 11 | Key switch for platform/off/ground selection
Turn the key switch to the platform position and the platform controls will operate. Turn the key switch to the off position and the machine will be off. Turn the key switch to the ground position and the ground controls will operate. |
| 5 | Platform up button | 12 | Tech Pro Link Connector |
| 6 | Platform down button | | |
| 7 | Lift function enable button
Press and hold this button to activate the lift function. | | |

Controls

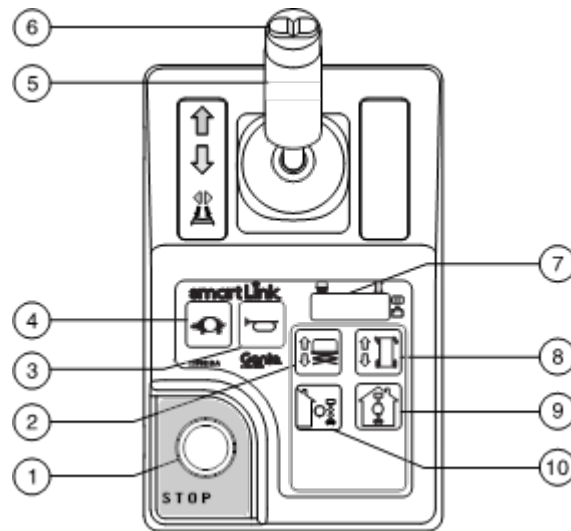

Platform Control Panel

1 Red Emergency Stop button

Push in the red Emergency Stop button to the off position to stop all functions. Pull out the red Emergency Stop button to the on position to operate the machine.

2 Lift function button

Push this button to activate the lift function.



3 Horn button

Press the horn button and the horn will sound. Release the horn button and the horn will not sound.



4 Drive speed select button

Press this button to activate the slow drive function. The indicator light will be on when slow drive is selected.



5 Proportional control handle and function enable switch for drive, steer, and lift functions

Lift function: Press and hold the function enable switch to enable the lift function on the platform control handle. Move the control handle in the direction indicated by the blue arrow and the platform will raise. Move the control handle in the direction indicated by the yellow arrow and the platform will lower. The descent alarm should sound while the platform is lowering.

Drive function: Press and hold the function enable switch to enable the drive function on the platform control handle. Move the control handle in the direction indicated by the blue arrow on the control panel and the machine will move in the direction that the blue arrow points. Move the control handle in the direction indicated by the yellow arrow on the control panel and the machine will move in the direction that the yellow arrow points.

Controls

6 Thumb rocker switch for steer function

Press the left side of the thumb rocker and the machine will turn in the direction the blue triangle points on the platform control panel.



Press the right side of the thumb rocker and the machine will turn in the direction the yellow triangle points on the platform control panel.



7 LED diagnostic readout, battery charge indicator and lift/drive mode indicator

8 Drive function button

Push this button to activate the drive function.



9 Indoor use button

Press this button for indoor use

Note: Selecting indoor use permits elevating to maximum indoor platform height. Refer to specification pages.



10 Outdoor use button

Press this button for outdoor use

Note: Selecting outdoor use permits elevating to maximum outdoor platform height. Refer to specification pages.



Inspections



Do Not Operate Unless:

- You learn and practice the principles of safe machine operation contained in this operator's manual.
 - 1 Avoid hazardous situations.
 - 2 Always perform a pre-operation inspection.**
 - Know and understand the pre-operation inspection before going on to the next section.**
 - 3 Always perform function tests prior to use.
 - 4 Inspect the workplace.
 - 5 Only use the machine as it was intended.

Pre-operation Inspection Fundamentals

It is the responsibility of the operator to perform a pre-operation inspection and routine maintenance.

The pre-operation inspection is a visual inspection performed by the operator prior to each work shift. The inspection is designed to discover if anything is apparently wrong with a machine before the operator performs the function tests.

The pre-operation inspection also serves to determine if routine maintenance procedures are required. Only routine maintenance items specified in this manual may be performed by the operator.

Refer to the list on the next page and check each of the items.

If damage or any unauthorized variation from factory delivered condition is discovered, the machine must be tagged and removed from service.

Repairs to the machine may only be made by a qualified service technician, according to the manufacturer's specifications. After repairs are completed, the operator must perform a pre-operation inspection again before going on to the function tests.

Scheduled maintenance inspections shall be performed by qualified service technicians, according to the manufacturer's specifications.

Inspections

Pre-operation Inspection

- Be sure that the operator's manual is complete, legible and in the storage container located in the platform.
- Be sure that all decals are legible and in place. See Inspections section.
- Check for hydraulic oil leaks and proper oil level. Add oil if needed. See Maintenance section.
- Check for battery fluid leaks and proper fluid level. Add distilled water if needed. See Maintenance section.

Check the following components or areas for damage, improperly installed, or missing parts and unauthorized modifications:

- Electrical components, wiring, and electrical cables
- Hydraulic power unit, reservoir, hoses, fittings, cylinders and manifolds
- Battery pack and connections
- Drive motors
- Tires and wheels
- Ground strap
- Limit switches, alarms and horn
- Beacons (if equipped)
- Nuts, bolts and other fasteners
- Platform entry mid-rail or gate
- Sequencing cables and pulleys
- Wear pads

- Pothole guards
- Lanyard anchorage points
- Platform extension (if equipped)
- Work trays (if equipped)
- Brake release components
- Battery cover
- Mast columns and counterweight
- Platform control joystick
- Platform overload components

Check entire machine for:

- Cracks in welds or structural components
- Dents or damage to machine
- Excessive rust, corrosion or oxidation
- Verify that all structural and other critical components are present and all associated fasteners and pins are in place and properly tightened.

Note: If the platform must be raised to inspect the machine, make sure that the battery cover is in place to prevent the mast sections and platform from coming down. See Operating Instructions section.

Inspections



Do Not Operate Unless:

- You learn and practice the principles of safe machine operation contained in this operator's manual.
 - 1 Avoid hazardous situations.
 - 2 Always perform a pre-operation inspection.
 - 3 Always perform function tests prior to use.**

Know and understand the function tests before going on to the next section.

- 4 Inspect the workplace.
- 5 Only use the machine as it was intended.

Function Test Fundamentals

The function tests are designed to discover any malfunctions before the machine is put into service. The operator must follow the step-by-step instructions to test all machine functions.

A malfunctioning machine must never be used. If malfunctions are discovered, the machine must be tagged and removed from service. Repairs to the machine may only be made by a qualified service technician, according to the manufacturer's specifications.

After repairs are completed, the operator must perform a pre-operation inspection and function tests again before putting the machine into service.

Inspections

At the Ground Controls

- 1 Select a test area that is firm, level and free of hazards.
- 2 Be sure the batteries are connected.
- 3 Pull out the platform and ground red Emergency Stop button to the on position.
- 4 Turn the key switch to ground control.
- 5 Observe the diagnostic LED readout on the platform controls.
- ⊙ Result: The LED should look like the picture below.



- 6 Observe the diagnostic LCD readout on the ground controls.
- ⊙ Result: The LCD should look like the picture below.

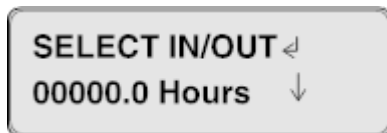

Test Emergency Stop

- 7 Push in the ground red Emergency Stop button to the off position.
- ⊙ Result: No functions should operate.
- 8 Pull out the red Emergency Stop button to the on position.

Test the Up/Down Functions

The audible warnings on this machine and the standard horn all come from the same central alarm. The horn is a constant tone. The descent alarm sounds at 60 beeps per minute. The alarm sounds at 180 beeps per minute when the pothole guards have not deployed and when the machine is not level. An optional automotive-style horn is also available.

- 9 Do not press the lift function enable button.
- 10 Press the platform up or platform down button.
- ⊙ Result: The lift function should not operate.
- 11 Do not press the platform up or platform down buttons.
- 12 Press the lift function enable button.
- ⊙ Result: The lift function should not operate.
- 13 Press and hold the lift function enable button, and press the platform up button.
- ⊙ Result: The lift function should not operate.
- 14 Press the Enter button to cycle between indoor and outdoor area of operation.
- 15 Select the outdoor area of operation.
- 16 Press and hold the lift function enable button, and press the platform up button.
- ⊙ Result: The platform should raise.
- 17 Press and hold the lift function enable button, and press the platform down button.
- ⊙ Result: The platform should lower. The descent alarm should sound while the platform is lowering.

Inspections

Test Auxiliary Lowering

- 18 Activate the up function by pressing the lift enable button and platform up button, and raise the platform approximately 2 ft. / 60 cm.
- 19 Pull the auxiliary lowering knob located at the base of the machine below the mast.
- ⊙ Result: The platform should lower. The descent alarm will not sound.

Test the Tilt Sensor Operation

- 20 Press the ground control down button (button 3) 
- ⊙ Result: The ground control LCD screen will display the status of the tilt sensor. The X and Y values (pitch and roll) will be displayed.
- 21 Turn the key switch to platform control.

At the Platform Controls

Test Emergency Stop

- 22 Push in the platform red Emergency Stop button to the off position.
- ⊙ Result: No functions should operate.

Test the Horn

- 23 Pull out the red Emergency Stop button to the on position.
- 24 Press the horn button.
- ⊙ Result: The platform alarm, chassis alarm, and automotive horn (if equipped) should sound.

Test the Function Enable Switch and the Up/Down Functions

- 25 Press the outdoor use button.
 - ⊙ Result: The outdoor use button should illuminate.
- 26 Do not hold the function enable switch on the control handle.
- 27 Slowly move the control handle in the direction indicated by the blue arrow, then in the direction indicated by the yellow arrow.
 - ⊙ Result: No functions should operate.
- 28 Press the lift function button.
- 29 Wait seven seconds for the lift function to time out.
- 30 Slowly move the control handle in the direction indicated by the blue arrow, then in the direction indicated by the yellow arrow.
 - ⊙ Result: The lift function should not operate.
- 31 Press the lift function button.
- 32 Press and hold the function enable switch on the control handle. Slowly move the control handle in the direction indicated by the blue arrow.
 - ⊙ Result: The platform should raise. The pothole guards should deploy.
- 33 Release the control handle.
 - ⊙ Result: The platform should stop raising.
- 34 Press and hold the function enable switch on the control handle. Slowly move the control handle in the direction indicated by the yellow arrow.
 - ⊙ Result: The platform should lower. The descent alarm should sound while the platform is lowering.

Inspections

Test the Outdoor Use Button

- 35 Do not press and hold the function enable switch on control handle.
- 36 Press the outdoor use button.
- ⊙ **Result:** The LED under the outdoor button will illuminate.
- 37 Press the lift function enable button.
- 38 Press and hold the function enable switch on the control handle. Slowly move the control handle in the direction indicated by the blue arrow.
- ⊙ **GR-12:** Result: The platform should raise to 9 ft 1 in/2.76 m and stop. The alarm should sound. The platform controls LED readout should display OHL.
- ⊙ **GR-15:** Result: The platform should raise to 11 ft 1 in/3.37 m and stop. The alarm should sound. The platform controls LED readout should display OHL.
- ⊙ **GR-20:** Result: The platform should raise to 15 ft 6 in/4.72 m and stop. The alarm should sound. The platform controls LED readout should display OHL.

Test the Drive Function Button

- 39 Press the drive function button. 
- 40 Wait seven seconds for the drive function to time out. Slowly move the control handle in the direction indicated by the blue arrow, then in the direction indicated by the yellow arrow.
- ⊙ **Result:** No functions should operate.

Test the Steering

Note: When performing the steer and drive function tests, stand in the platform facing the steer end of the machine.

- 41 Press the drive function button. 
- 42 Press and hold the function enable switch on the control handle.
- 43 Press the thumb rocker switch on top of the control handle in the direction indicated by the blue triangle on the control panel.
- ⊙ **Result:** The steer wheels should turn in the direction indicated by the blue triangle.
- 44 Press the thumb rocker switch on top of the control handle in the direction indicated by the yellow triangle, on the control panel.
- ⊙ **Result:** The steer wheels should turn in the direction indicated by the yellow triangle.

Inspections

Test Drive and Braking

45 Press the drive function button.



- 46 Press and hold the function enable switch on the control handle.
- 47 Slowly move the control handle in the direction indicated by the blue arrow on the control panel until the machine begins to move, then return the control handle to the center position.
- ⊙ Result: The machine should move in the direction that the blue arrow points on the control panel, then come to an abrupt stop when the control handle is returned to the center position.
- 48 Slowly move the control handle in the direction indicated by the yellow arrow on the control panel until the machine begins to move, then return the control handle to the center position.
- ⊙ Result: The machine should move in the direction that the yellow arrow points on the control panel, then come to an abrupt stop when the control handle is returned to the center position.

Note: The brakes must be able to hold the machine on any slope it is able to climb.

Test Drive Tilt Cutout

Note: Perform this test from the ground with the platform controller. Do not stand in the platform.

- 49 Fully lower the platform.
- 50 Drive the machine onto a slope where the chassis angle is greater than 1.5° side to side.
- 51 Raise the platform to approximately 7 ft/2.13 m.
- ⊙ Result: The platform should stop and the tilt alarm will sound at 180 beeps per minute. The platform controls LED readout should display LL and the ground controls LCD should display LL: Machine Tilted.
- 52 Press the drive function button.
- 53 Press and hold the function enable switch on the control handle.
- 54 Move the control handle in the direction indicated by the blue arrow, then move the control handle in the direction indicated by the yellow arrow.
- ⊙ Result: The drive function should not work in either direction.
- 55 Fully lower the platform.
- 56 Drive the machine.
- ⊙ Result: The machine should drive.
- 57 Return to level ground and raise the platform in excess of approximately 7 ft/2.13 m.

Inspections

- 58 Drive the machine onto a slope where the pitch angle is greater than 1.5° side to side.
- ⦿ Result: The machine should stop once the machine reaches 1.5° of chassis tilt and the tilt alarm will sound at 180 beeps per minute. The platform controls LED readout should display LL and the ground controls LCD should display LL: Machine Tilted
- 59 Return to level ground and fully lower the platform.
- 60 Drive the machine onto a slope where the chassis angle is greater than 3° front to back.
- 61 Raise the platform to approximately 7 ft/2.13 m.
- ⦿ Result: The platform should stop and the tilt alarm will sound at 180 beeps per minute. The platform controls LED readout should display LL and the ground controls LCD should display LL: Machine Tilted.
- 62 Press the drive function button.
- 63 Press and hold the function enable switch on the control handle.
- 64 Move the control handle in the direction indicated by the blue arrow, then move the control handle in the direction indicated by the yellow arrow.
- ⦿ Result: The drive function should not work in either direction.
- 65 Fully lower the platform.
- 66 Drive the machine.
- ⦿ Result: The machine should drive.
- 67 Return to level ground and raise the platform in excess of approximately 7 ft/2.13 m.
- 68 Drive the machine onto a slope where the pitch angle is greater than 3° front to back.
- ⦿ Result: The machine should stop once the machine reaches 3° of chassis tilt and the tilt alarm will sound at 180 beeps per minute. The platform controls LED readout should display LL and the ground controls LCD should display LL: Machine Tilted
- 69 Fully lower the platform and return to level ground.

Test Elevated Drive Speed

- 70 Raise the platform approximately 4 ft / 1.2 m from the ground.
- 71 Press the drive function button.
- 72 Press and hold the function enable switch on the control handle. Slowly move the control handle to full drive position.
- ⦿ Result: The maximum achievable drive speed with the platform raised should not exceed 0.72 ft / 22 cm per second.



If the drive speed with the platform raised exceeds 0.72 ft / 22 cm per second, immediately tag and remove the machine from service.

Inspections

Test the Pothole Guards

Note: The pothole guards should automatically deploy when the platform is raised. The pothole guards activate limit switches that allow the machine to continue to function. If the pothole guards do not deploy, an alarm sounds and the machine will not drive or steer.

73 Raise the platform.

- ⦿ Result: When the platform is raised approximately 4 ft / 1.2 m from the ground, the pothole guards should deploy.

74 Press on the pothole guards on one side, and then the other.

- ⦿ Result: The pothole guards should not move.

75 Lower the platform.

- ⦿ Result: The pothole guards should return to the stowed position.

76 Place a 2x4 or similar piece of wood under a pothole guard.

77 Raise the platform.

- ⦿ Result: Before the platform is raised approximately 7 ft / 2.1 m from the ground, an alarm should sound. The platform controls LED readout should display PHS and the ground controls LCD should display PHS: Pothole Guard Stuck.

78 Press the drive function button.



79 Press and hold the function enable switch on the control handle.

80 Slowly move the control handle in the direction indicated by the blue arrow, then in the direction indicated by the yellow arrow.

- ⦿ Result: The machine should not move forward or backward.

81 Press the drive function button.



82 Press and hold the function enable switch on the control handle.

83 Press the thumb rocker switch on top of the control handle in the direction indicated by the blue and yellow triangles on the control panel.

- ⦿ Result: The steer wheels should not turn left or right.

84 Fully lower the platform.

85 Remove the 2x4 or similar piece of wood.

Inspections



Do Not Operate Unless:

- You learn and practice the principles of safe machine operation contained in this operator's manual.
 - 1 Avoid hazardous situations.
 - 2 Always perform a pre-operation inspection.
 - 3 Always perform function tests prior to use.
 - 4 Inspect the workplace.**

Know and understand the workplace inspection before going on to the next section.
 - 5 Only use the machine as it was intended.

Workplace Inspection Checklist

Be aware of and avoid the following hazardous situations:

- drop-offs or holes
- bumps, floor obstructions, or debris
- sloped surfaces
- unstable or slippery surfaces
- overhead obstructions and high voltage conductors
- hazardous locations
- inadequate surface support to withstand all load forces imposed by the machine
- wind and weather conditions
- the presence of unauthorized personnel
- other possible unsafe conditions

Workplace Inspection Fundamentals

The workplace inspection helps the operator determine if the workplace is suitable for safe machine operation. It should be performed by the operator prior to moving the machine to the workplace.

It is the operator's responsibility to read and remember the workplace hazards, then watch for and avoid them while moving, setting up, and operating the machine.

Inspections

Inspection for Decals with Symbols

Use the inspection to verify that all decals are legible and in place.

Part No.	Decal Description	Qty
28174	Label – Power to Platform, 230V*	2
28235	Label – Power to Platform, 115V*	2
43658	Label – Power to Charger, 230V*	1
44980	Label – Power to Charger, 115V*	1
52475	Label – Transport Tie-down	3
72086	Label – Lifting Point	1
72188	Label – Directional Arrows	2
82481	Label – Battery/Charger Safety	1
82487	Label – Read the Manual	2
82495	Label – Brake Release Safety and Operating Instructions	1
82614	Warning – Collision Hazard	1
82666	Label – Forklift Pocket	2
82836	Label – Auxiliary Lowering	1
97815	Label – Lower Mid-rail*	1
97899	Label – Use Safety Chock	1
114334	Label – Electrocutation Hazard, Plug	1
114338	Label – Tip-over Hazard, Tilt Alarm	1
133015	Danger – Electrocutation hazard	1
133146	Danger – Tip-over Hazard, Batteries	1
133147	Label – Tip-over Hazard, Limit Switch	1
137605	Label – Emergency Stop, Platform Control	1
137656	Label – Drive/Steer Direction, Platform Control	1
1263542	Label – Compartment Access	1
1270489	Label – Wheel Load, GR, GRC	4
1272242	Label – Machine Registration/Owner Transfer	1
1281175	Label – Lanyard Anchorage Point, Fall Restrained	1
1283228	Label – GCON, GR, Tech Pro	1
1283810	Label – Platform Control Panel	1
1293166	Danger, Warning – Tip-over, Crush Hazard	1
1294688	Label – Platform Overload LED Indicator Light	1

Part No.	Decal Description	Qty
1296034	Label – Smartlink Dual Zone	2
1296620	Danger – Max. Capacity, Side Force, GR*	1
1296622	Danger – Max. Capacity, Side Force, GR*	1
1297735	Label – Transport Diagram	2
1298467	Label – Read the Manual	1

* These decals are model, option or configuration specific.

Inspections

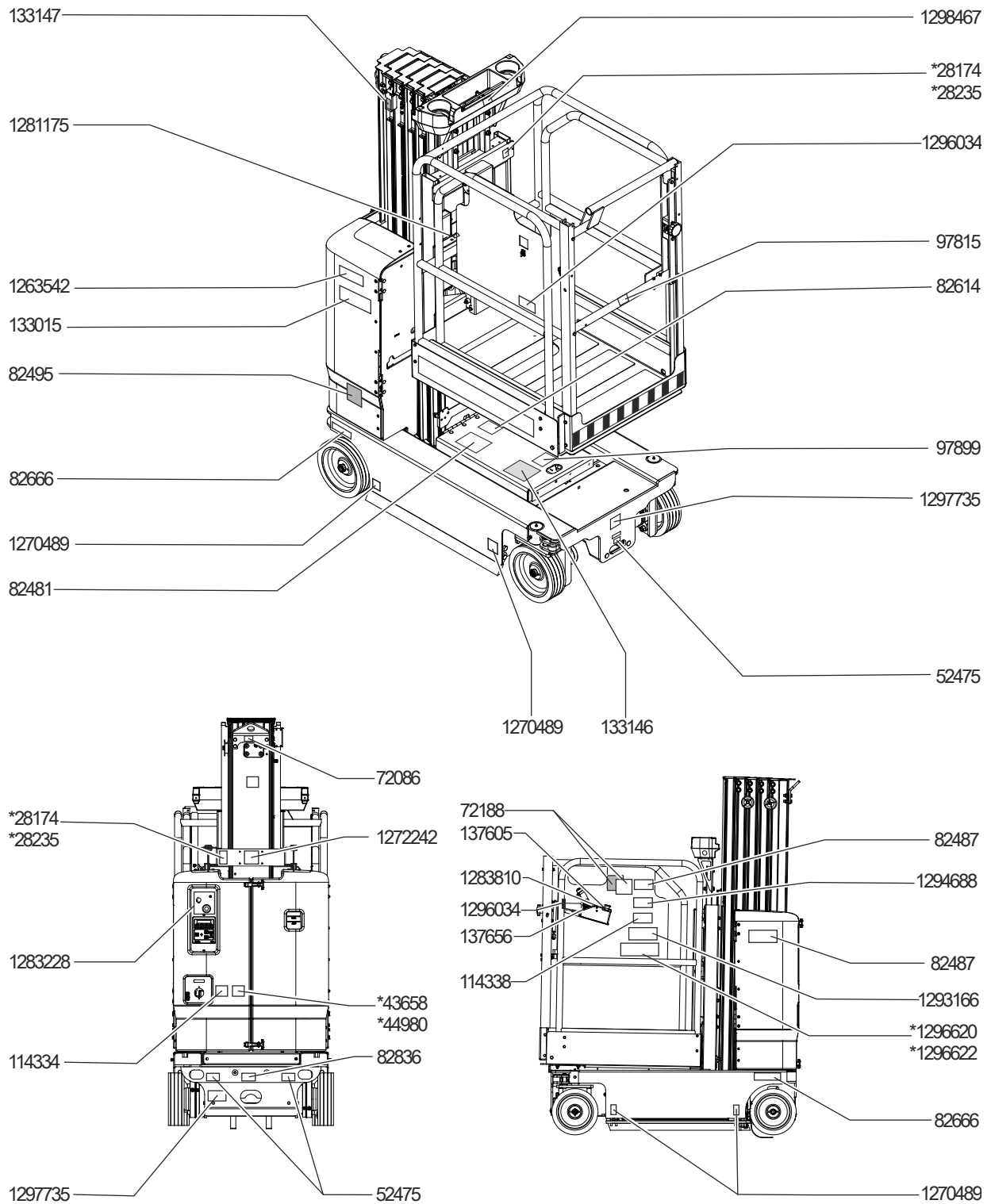

Operating Instructions



Do Not Operate Unless:

- You learn and practice the principles of safe machine operation contained in this operator's manual.
 - 1 Avoid hazardous situations.
 - 2 Always perform a pre-operation inspection.
 - 3 Always perform function tests prior to use.
 - 4 Inspect the workplace.
 - 5 **Only use the machine as it was intended.**

Fundamentals

The Operating Instructions section provides instructions for each aspect of machine operation. It is the operator's responsibility to follow all the safety rules and instructions in the operator's manual.

Using the machine for anything other than lifting personnel, along with their tools and materials, to an aerial work site is unsafe and dangerous.

Only trained and authorized personnel should be permitted to operate a machine. If more than one operator is expected to use a machine at different times in the same work shift, they must all be qualified operators and are all expected to follow all safety rules and instructions in the operator's manual. That means every new operator should perform a pre-operation inspection, function tests, and a workplace inspection before using the machine.

Operating Instructions

Emergency Stop

Push in the red Emergency Stop button to the off position at the ground controls or the platform controls to stop all functions.

Repair any function that operates when either red Emergency Stop button is pushed in.

Auxiliary Lowering

Pull the auxiliary lowering knob to lower the platform.



Operation from Ground

- 1 Be sure the battery pack is connected before operating the machine.
- 2 Turn the key switch to ground control.
- 3 Pull out both ground and platform red Emergency Stop buttons to the on position.

To Position Platform

- 1 At the control panel, press Enter button to cycle between indoor and outdoor area of operations.

Note: Area of operation can only be changed when the machine is in the stowed position.

- 2 Press and hold the lift function enable.
- 3 Press the platform up or down button.

Operation from Platform

- 1 Be sure the battery pack is connected before operating the machine.
- 2 Turn the key switch to platform control.
- 3 Pull out both ground and platform red Emergency Stop buttons to the on position.

To Position Platform

- 1 Press the Indoor or Outdoor use button.



Note: Area of operation can only be changed when the machine is in the stowed position.

- 2 Press the lift function button. On the LED screen, a circle below the lift function symbol will turn on.



If the control handle is not moved within seven seconds of pushing the lift function button, the circle below the lift function symbol will turn off and lift function will not operate. Press the lift function button again.

- 3 Press and hold the function enable switch on the control handle.
- 4 Move the control handle in the direction indicated by the markings on the control panel.

Operating Instructions

To Steer

- 1 Press the drive function button. On the LED screen, a circle below the drive function symbol will turn on.

If the control handle is not moved within seven seconds of pushing the drive function button, the circle below the drive function symbol will turn off and drive function will not operate. Press the drive function button again.

- 2 Turn the steer wheels with the thumb rocker switch located on the top of the control handle.



To Drive

- 1 Press the drive function button. On the LED screen, a circle below the drive function symbol will turn on.

If the control handle is not moved within seven seconds of pushing the drive function button, the circle below the drive function symbol will turn off and drive function will not operate. Press the drive function button again.

- 2 Press and hold the function enable switch on the control handle.

- 3 Increase speed: Slowly move the control handle off center.

Decrease speed: Slowly move the control handle toward center.

Stop: Return the control handle to center or release the function enable switch.

Use the color-coded direction arrows on the platform controls and on the platform to identify the direction the machine will travel.

Machine travel speed is restricted when the platform is raised.

Battery condition will affect machine performance. Machine drive speed and function speed will drop when the battery level indicator is flashing.

To select drive speed

The drive controls can operate in two different drive speed modes. When the drive speed button light is on, slow drive speed mode is active. When the button light is off, fast drive speed mode is active.

Press the drive speed button to select the desired drive speed.



Note: When the platform is elevated, the drive speed button light is always on, indicating elevated drive speed.

Operating Instructions

▲ Driving on a slope

Determine the slope and side slope ratings for the machine and determine the slope grade.



Maximum slope rating, stowed position: 30% (17°)



Maximum side slope rating, stowed position: 30% (17°)

Note: Slope rating is subject to ground conditions with one person in the platform and adequate traction. Additional platform weight may reduce slope rating.

To determine the slope grade:

Measure the slope with a digital inclinometer OR use the following procedure.

You will need:

- carpenter's level
- straight piece of wood, at least 3 feet/1 m long
- tape measure

Lay the piece of wood on the slope.

At the downhill end, lay the level on the top edge of the piece of wood and lift the end until the piece of wood is level.

While holding the piece of wood level, measure the vertical distance from the bottom of the piece of wood to the ground.

Divide the tape measure distance (rise) by the length of the piece of wood (run) and multiply by 100.

Example:

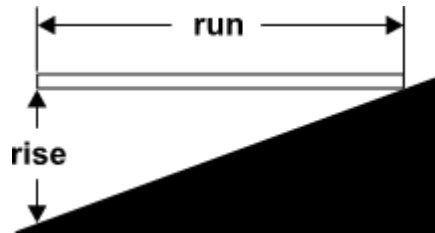

Piece of wood = 144 inches (3.6 m)

Run = 144 inches (3.6 m)

Rise = 12 inches (0.3 m)

$12 \text{ in} \div 144 \text{ in} = 0.083 \times 100 = 8.3\% \text{ grade}$

$0.3 \text{ m} \div 3.6 \text{ m} = 0.083 \times 100 = 8.3\% \text{ grade}$

If the slope exceeds the maximum slope or side slope rating, then the machine must be winched or transported up or down the slope. See Transport and Lifting section.

Operating Instructions

Operational indicator codes

If the platform controls LED or ground controls LCD diagnostic readout displays an operational indicator code such as LL, the fault condition must be repaired or removed before resuming machine operation. Push in and pull out the red Emergency Stop button to reset the system.



LED Readout

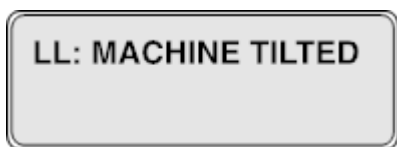

LCD Readout

Operational Indicator Codes

Code	Condition
LL	Off-Level
OL	Platform Overloaded
CH	Chassis Mode Operation
PHS	Pothole Guard Stuck
ND	No Drive (option)
OHL	Outdoor Height Limit

For further information, please consult the appropriate Genie Service Manual. A code and a description of a code can also be viewed at the ground controls LCD display.

Platform Overload

If the platform controls LED diagnostic readout displays a flashing OL and the ground controls LCD diagnostic readout displays OL: Platform Overloaded, the platform is overloaded and no functions will operate. An alarm will sound.

- 1 Push in the red Emergency Stop button to the off position.
- 2 Remove weight from the platform.
- 3 Pull out the red Emergency Stop button to the on position.



LED Readout



LCD Readout

When the platform is being raised or lowered, a self-check function will be performed near maximum height. The machine may stop and an alarm may sound. If the machine is not overloaded, normal operation will resume.

Overload Recovery

If the ground controls LCD diagnostic readout displays Overload Recovery, the auxiliary lowering system has been used while the platform was overloaded. For information on how to reset the message, please consult the appropriate Genie Service Manual.

Operating Instructions

Tilt Sensor Activation Settings

Chassis Angle (side to side)	1.5°
Chassis Angle (front to back)	3°

If the tilt alarm sounds while raising the platform, lower the platform and move the machine to a firm, level surface. If the tilt alarm sounds when the platform is raised, use extreme caution to lower the platform.



When the platform controls LED readout displays LL, the ground controls LCD displays LL: Machine Tilted, and the tilt alarm sounds at 180 beeps per minute, the following functions are affected: drive, steer, and elevate functions are disabled.



Return the machine to level ground to restore lift functions.

Operation from Ground with Controller

Maintain safe distances between the operator, machine and fixed objects.

Be aware of the direction the machine will travel when using the controller.

Battery Level Indicator

Use the LED diagnostic readout to determine the battery level.

Note: When a blinking LO code appears on the platform controls LED display, the machine must be taken out of service and charged, otherwise all machine functions will be disabled.



Full Charge



Half Charge



Low Charge



LO Flashing

Operating Instructions

To Extend and Retract Platform (if equipped)

- 1 Step on the platform extension release pedal.
- 2 Grasp the platform guard rails carefully and push to extend the platform.
- 3 Step on the platform extension release pedal and pull the guard rails to retract the platform.

Lift Tools Work Tray Instructions

The Lift Tools Work Tray assembly consists of one tray and a mounting bracket with hardware.

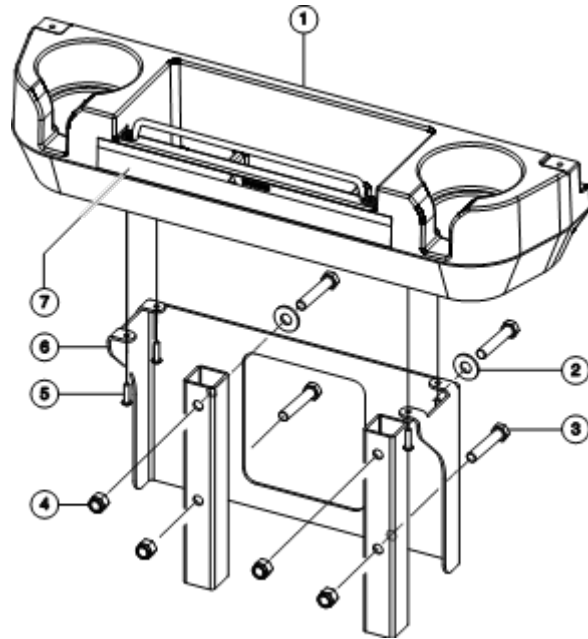

- 1 lift tool work tray
- 2 washer, flat, 3/8"
- 3 bolt, 3/8-16 x 2"
- 4 nut, nylock, 3/8-16
- 5 bolt, #10-24 x 0.50"
- 6 tool tray bracket
- 7 decal, warning

Operating Instructions

Observe and Obey: Lift Tools Work Tray Installation

- ☑ Lift Tools Work Tray must be installed on the inside of the platform.
- ☑ Only one Lift Tools Work Tray can be used per machine.
- ☑ Mount Lift Tools Work Tray on the top of the Platform Support near the mast only.
- ☑ Be sure the Lift Tools Work Tray is secured to the Platform Support.
- ☑ Lift Tools Work Tray lanyard is for tools only. Do not attach personal safety lanyard.

Lift Tools Work Tray Operation

- 1 Place the load so that it rests inside the Lift Tools Work Tray.

The Lift Tools Work Tray assembly weighs 4 lbs / 1.8 kg.

Maximum capacity of Lift Tools Work Tray is 50 lbs / 23 kg.

- ⚠ Tip-over hazard. The weight of Lift Tools Work Tray assembly and the load in the Lift Tools Work Tray assembly will reduce the rated platform capacity of the machine and must be factored into the total platform load.

Operating Instructions



Battery and Charger Instructions

Observe and Obey:

- Do not use an external charger or booster battery.
- Charge the battery in a well-ventilated area.
- Use proper AC input voltage for charging as indicated on the charger.
- Use only a Genie authorized battery and charger.

To Charge Battery

- 1 Be sure the batteries are connected before charging the batteries.
- 2 The compartment may remain closed for the entire charging cycle.

Maintenance-free batteries

- 1 Connect the battery charger to a grounded AC circuit.
- 2 The charger will indicate when the battery is fully charged.

Standard Batteries

- 1 Remove the battery vent caps and check the battery acid level. If necessary, add only enough distilled water to cover the plates. Do not overfill prior to the charge cycle.
- 2 Replace the battery vent caps.
- 3 Connect the battery charger to a grounded AC circuit.
- 4 The charger will indicate when the battery is fully charged.
- 5 Check the battery acid level when the charging cycle is complete. Replenish with distilled water to the bottom of the fill tube. Do not overfill.

Operating Instructions

After Each Use

- 1 Select a safe parking location—firm level surface, clear of obstruction and traffic.
- 2 Lower the platform.
- 3 Turn the key switch to the off position and remove the key to secure from unauthorized use.
- 4 Charge the batteries.

Transport and Lifting Instructions





Observe and Obey:

- Genie provides this securement information as a recommendation. Drivers are solely responsible for making sure machines are properly secured and the correct trailer is selected.
 - Genie customers needing to containerize any lift or Genie product should source a qualified freight forwarder with expertise in preparing, loading and securing construction and lifting equipment for international shipment.
 - Only qualified mobile elevating work platform operators should move the machine on or off the truck.
 - The transport vehicle must be parked on a level surface.
 - The transport vehicle must be secured to prevent rolling while the machine is being loaded.
 - Be sure the vehicle capacity, loading surfaces and chains or straps are sufficient to withstand the machine weight. Genie lifts are very heavy relative to their size. See the serial label for the machine weight. See the inspections section for the serial label location.
- The machine must be on a level surface or secured before releasing the brakes.
 - Do not drive the machine on a slope that exceeds the uphill, downhill or side slope rating. See Driving on a Slope in the Operating Instructions section.
 - If the slope of the transport vehicle bed exceeds the uphill or downhill maximum slope rating, the machine must be loaded and unloaded using a winch or forklift as described in the brake release operation. See the Specifications section for the slope ratings.

Transport and Lifting Instructions

Brake Release Operation

- 1 Chock the wheels to prevent the machine from rolling. 
- 2 Be sure the winch line is properly secured to the drive chassis tie points and the path is clear of all obstructions.
- 3 Push in the black brake release knob to open the brake valve. 
- 4 Pump the red brake release pump knob.

After the machine is loaded:

- 1 Chock the wheels to prevent the machine from rolling.
- 2 Pull out the red Emergency Stop button at both the ground and platform controls to the on position, and turn the key switch to the platform position.
- 3 Press the drive function button. 
- 4 Press and hold the function enable switch on the control handle. Move the control handle off center and immediately release it to reset the brakes.
- 5 Push the red Emergency stop button at both the ground and platform controls to the off position.

Towing the GR-12, the GR-15, and the GR-20 is not recommended. If the machine must be towed, do not exceed 2 mph / 3.2 km/h.

Transport and Lifting Instructions

Securing to Truck or Trailer for Transit

Always use the extension deck lock when the machine is transported.

Turn the key switch to the off position and remove the key before transporting.

Inspect the entire machine for loose or unsecured items.

Use the tie-down points on the chassis for anchoring down to the transport surface.

Use chains or straps of ample load capacity.

Use a minimum of 2 chains or straps.

Adjust the rigging to prevent damage to the chains.

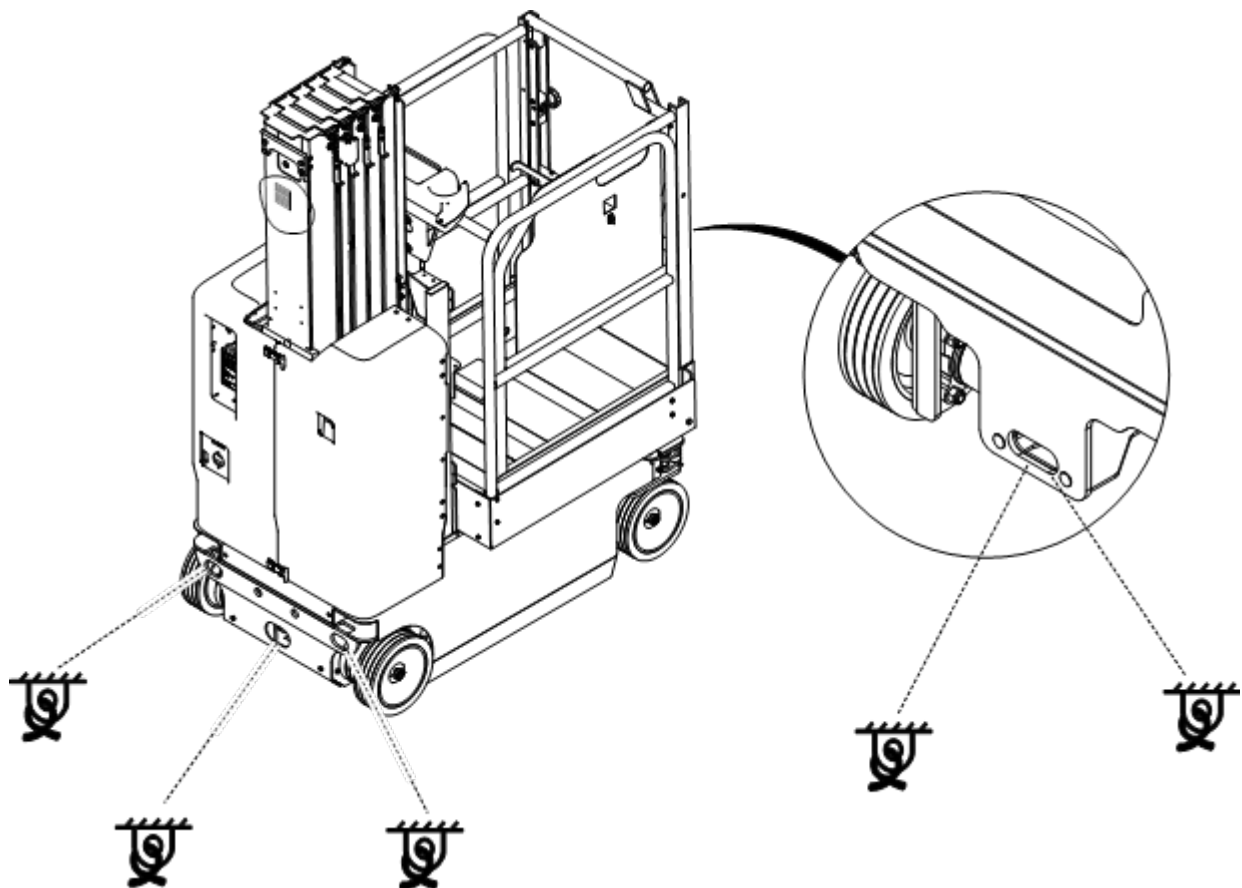

Transport and Lifting Instructions



Observe and Obey:

- ☑ Only qualified riggers should rig and lift the machine.
- ☑ Only qualified forklift operators should lift the machine with a forklift.
- ☑ Be sure the crane capacity, loading surfaces and straps or lines are sufficient to withstand the machine weight. See the serial label for the machine weight.

Lifting the Machine with a Forklift

Be sure the extension deck, controls and component trays are secure. Remove all loose items on the machine.

Fully lower the platform. The platform must remain lowered during all loading and transport procedures.

Use the forklift pockets located on both sides of the chassis, below the covers.

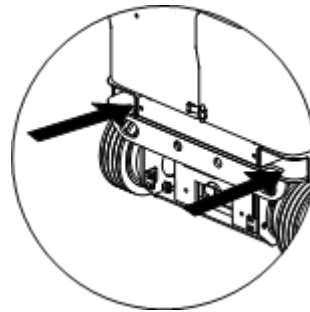

Position the forklift forks in position with the forklift pockets.

Drive forward to the full extent of the forks.

Raise the machine 6 in / 15 cm and then tilt the forks back slightly to keep the machine secure.

Be sure the machine is level when lowering the forks.

NOTICE

Lifting the machine from the side can result in component damage.

Transport and Lifting Instructions

Loading the Machine With a Crane

Fully lower the platform. Be sure the extension deck, controls and component trays are secure. Remove all loose items on the machine.

Use the lifting eye mounted on the rear mast column.

Make sure the mast is fully lowered.

Inspect the entire machine and remove any loose or unsecured items.

Adjust the rigging to prevent damage to the machine and to keep the machine level.

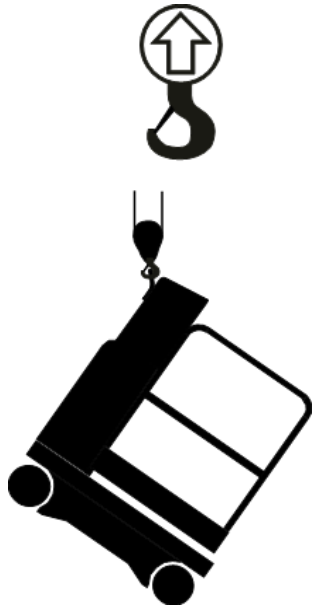

Maintenance



Observe and Obey:

- ☑ Only routine maintenance items specified in this manual shall be performed by the operator.
- ☑ Scheduled maintenance inspections shall be performed by qualified service technicians, according to the manufacturer's specifications.
- ☑ Dispose of material in accordance with governmental regulations.
- ☑ Use only Genie approved replacement parts.

Maintenance Symbols Legend

The following symbols have been used in this manual to help communicate the intent of the instructions. When one or more of the symbols appear at the beginning of a maintenance procedure, it conveys the meaning below.



Indicates that tools will be required to perform this procedure.



Indicates that new parts will be required to perform this procedure.

Check the Hydraulic Oil Level



Maintaining the hydraulic oil at the proper level is essential to machine operation. Improper hydraulic oil levels can damage hydraulic components. Daily checks allow the inspector to identify changes in oil level that might indicate the presence of hydraulic system problems.

- 1 Be sure that the machine is on a firm, level surface, free of obstructions, with the platform in the stowed position.
- 2 Visually inspect the oil level in the hydraulic oil tank.
- ⊙ **Result:** The hydraulic oil level should be between the ADD and FULL marks on the tank.
- 3 Add oil as needed. Do not overfill.

Hydraulic oil specifications

Hydraulic oil type	Chevron Rando HD equivalent
--------------------	-----------------------------

Maintenance

Check the Batteries



Proper battery condition is essential to good machine performance and operational safety. Improper fluid levels or damaged cables and connections can result in component damage and hazardous conditions.

- ▲ **Electrocution hazard.** Contact with hot or live circuits may result in death or serious injury. Remove all rings, watches and other jewelry.
- ▲ **Bodily injury hazard.** Batteries contain acid. Avoid spilling or contacting battery acid. Neutralize battery acid spills with baking soda and water.

Note: Perform this test after fully charging the batteries.

- 1 Put on protective clothing and eye wear.
- 2 Be sure that the battery cable connections are tight and free of corrosion.
- 3 Be sure that the battery hold-down brackets are in place and secure.

Note: Adding terminal protectors and a corrosion preventative sealant will help eliminate the corrosion on the battery terminals and cables.

Scheduled Maintenance

Maintenance performed quarterly, annually and every two years must be completed by a person trained and qualified to perform maintenance on this machine according to the procedures found in the service manual for this machine.

Machines that have been out of service for more than three months must receive the quarterly inspection before they are put back into service.

Specifications

Model	GR-12	
Height, working maximum indoor	17 ft 4 in	5.3 m
Height, working maximum outdoor	15 ft 1 in	4.60 m
Height, platform maximum indoor	11 ft 4 in	3.5 m
Height, platform maximum outdoor	9 ft 1 in	2.8 m
Height, stowed maximum	70 in	177.8 cm
Width	29.5 in	74.9 cm
Length, stowed	53 in	134.6 cm
Length, platform extended (option)	73.3 in	1.85 m
Platform dimensions, all models (length x width)		
Standard platform	35 x 29.5 in	88.9 x 74.9 cm
Standard platform with extension extended	55 x 29.5 in	139.7 x 74.9 cm
Maximum capacity, standard platform	500 lbs	227 kg
Maximum wind speed, outdoors	28 mph	12.5 m/s
Maximum wind speed, indoors	0 mph	0 m/s
Turning radius (inside)	0 in	0 cm
Turning radius (outside)	52 in	132.1 cm
Ground clearance	2.5 in	6.5 cm
Weight	1681 lbs	763 kg
(Machine weights vary with option configurations. See serial label for specific machine weight.)		
Power source	4 Batteries, 6V 225AH	
AC outlet in platform	Standard	
Maximum hydraulic pressure (functions)	3500 psi	241 bar
Tire size	10 x 3 x 1 in 25.4 x 7.6 x 2.5 cm	

Airborne noise emissions

Sound pressure level at ground workstation <70 dBA

Sound pressure level at platform workstation <70 dBA

Total vibration value to which the hand/arm system is subjected does not exceed 2.5 m/s².

Highest root mean square value of weighted acceleration to which the whole body is subjected does not exceed 0.5 m/s².

Maximum slope rating, stowed position 30% (16.7°)

Maximum side slope rating, stowed position 30% (16.7°)

Note: Slope rating is subject to ground conditions with one person in the platform and adequate traction. Additional platform weight may reduce slope rating.

Maximum allowable chassis inclination Refer to "Tilt Sensor Activation Settings" section

Drive speeds

Stowed, maximum 2.5 mph 4.0 km/h
40 ft/10.9 sec 12.2 m/10.9 sec

Platform raised, maximum 0.5 mph 0.8 km/h
40 ft/55 sec 12.2 m/55 sec

Floor loading information

Tire load maximum 680 lbs 308 kg

Tire contact pressure 104.62 psi 7.36 kg / cm²
721.3 kPa

Occupied floor pressure 200.87 psf 980.7 kg / m²
9.62 kPa

Note: Floor loading information is approximate and does not incorporate different option configurations. It should be used only with adequate safety factors.

Continuous improvement of our products is a Genie policy. Product specifications are subject to change without notice or obligation.



Specifications

Model	GR-15	
Height, working maximum indoor	20 ft 8 in	6.3 m
Height, working maximum outdoor	17 ft 1 in	5.2 m
Height, platform maximum indoor	14 ft 8 in	4.5 m
Height, platform maximum outdoor	11 ft 1 in	3.4 m
Height, stowed maximum	70 in	177.8 cm
Width	29.5 in	74.9 cm
Length, stowed	53 in	1.35 m
Length, platform extended (option)	73.3 in	1.85 m
Platform dimensions, all models (length x width)		
Standard platform	35 x 88.9 x 74.9 cm 29.5 in	
Standard platform with extension extended	55 x 139.7 x 74.9 cm 29.5 in	
Maximum capacity, standard platform	500 lbs	227 kg
Maximum wind speed, outdoors	28 mph	12.5 m/s
Maximum wind speed, indoors	0 mph	0 m/s
Turning radius (inside)	0 in	0 cm
Turning radius (outside)	52 in	132.1 cm
Ground clearance	2.5 in	6.5 cm
Weight	2178 lbs	988 kg
(Machine weights vary with option configurations. See serial label for specific machine weight.)		
Power source	4 Batteries, 6V 225AH	
AC outlet in platform	Standard	
Maximum hydraulic pressure (functions)	3500 psi	241 bar
Tire size	10 x 3 x 1 in 25.4 x 7.6 x 2.5 cm	

Airborne noise emissions

Sound pressure level at ground workstation	<70 dBA
--	---------

Sound pressure level at platform workstation	<70 dBA
--	---------

Total vibration value to which the hand/arm system is subjected does not exceed 2.5 m/s².

Highest root mean square value of weighted acceleration to which the whole body is subjected does not exceed 0.5 m/s².

Maximum slope rating, stowed position	30% (16.7°)
--	-------------

Maximum side slope rating, stowed position	30% (16.7°)
---	-------------

Note: Slope rating is subject to ground conditions with one person in the platform and adequate traction. Additional platform weight may reduce slope rating.

Maximum allowable chassis inclination	Refer to "Tilt Sensor Activation Settings" section
--	--

Drive speeds

Stowed, maximum	2.5 mph 40 ft/10.9 sec	4.0 km/h 12.2 m/10.9 sec
-----------------	---------------------------	-----------------------------

Platform raised, maximum	0.5 mph 40 ft/55 sec	0.8 km/h 12.2 m/55 sec
--------------------------	-------------------------	---------------------------

Floor loading information

Tire load maximum	720 lbs	327 kg
-------------------	---------	--------

Tire contact pressure	110.77 psi	7.79 kg / cm ² 763.7 kPa
-----------------------	------------	--

Occupied floor pressure	251.99 psf psf	1230 kg/m ² 12.07 kPa
-------------------------	----------------	-------------------------------------

Note: Floor loading information is approximate and does not incorporate different option configurations. It should be used only with adequate safety factors.

Continuous improvement of our products is a Genie policy. Product specifications are subject to change without notice or obligation.



Specifications

Model	GR-20	
Height, working maximum indoor	25 ft 9 in	7.9 m
Height, working maximum outdoor	21 ft 6 in	6.6 m
Height, platform maximum indoor	19 ft 9 in	6.0 m
Height, platform maximum outdoor	15 ft 6 in	4.7 m
Height, stowed maximum	78 in	198.1 cm
Width	31.5 in	80 cm
Length, stowed	53 in	1.35 m
Length, platform extended (option)	73.3 in	1.86 m
Platform dimensions, all models (length x width)		
Standard platform	35 x 29.5 in	89.9 x 74.9 cm
Standard platform with extension extended	55 x 29.5 in	139.7 x 74.9 cm
Maximum capacity, standard platform	350 lbs	159 kg
Maximum wind speed, outdoors	28 mph	12.5 m/s
Maximum wind speed, indoors	0 mph	0 m/s
Turning radius (inside)	0 in	0 cm
Turning radius (outside)	53 in	134.6 cm
Ground clearance	2.5 in	6.5 cm
Weight	2513 lbs	1140 kg
(Machine weights vary with option configurations. See serial label for specific machine weight.)		
Power source	4 Batteries, 6V 225AH	
AC outlet in platform	Standard	
Maximum hydraulic pressure (functions)	3500 psi	241 bar
Tire size	10 x 3 x 1 in 25.4 x 7.6 x 2.5 cm	

Airborne noise emissions

Sound pressure level at ground workstation <70 dBA

Sound pressure level at platform workstation <70 dBA

Total vibration value to which the hand/arm system is subjected does not exceed 2.5 m/s².

Highest root mean square value of weighted acceleration to which the whole body is subjected does not exceed 0.5 m/s².

Maximum slope rating, stowed position 30% (16.7°)

Maximum side slope rating, stowed position 30% (16.7°)

Note: Slope rating is subject to ground conditions with one person in the platform and adequate traction. Additional platform weight may reduce slope rating.

Maximum allowable chassis inclination Refer to "Tilt Sensor Activation Settings" section

Drive speeds

Stowed, maximum 2.5 mph 4.0 km/h
40 ft/10.9 sec 12.2 m/10.9 sec

Platform raised, maximum 0.5 mph 0.8 km/h
40 ft/55 sec 12.2 m/55 sec

Floor loading information

Tire load maximum 870 lbs 395 kg

Tire contact pressure 133.85 psi 9.41 kg / cm²
922.84 kPa

Occupied floor pressure 250.39 psf 1223 kg/m²
11.99 kPa

Note: Floor loading information is approximate and does not incorporate different option configurations. It should be used only with adequate safety factors.

Continuous improvement of our products is a Genie policy. Product specifications are subject to change without notice or obligation.



Specifications

Contents of EC Declaration of Conformity - 1

<Manufacturer's name> hereby declares that the machinery described below complies with the provisions of the following Directives:

1. EC Directive 2006/42/EC, Machinery Directive, under consideration of harmonized European standard EN280 as described in EC type-examination certificate <variable field> issued by:

<notified body's name>

<notified body's number>

2. EC Directive EMC: 2014/30/EU, under consideration of harmonized European standard EN 61000-6-2 and EN 61000-6-4

3. EC Directive 2000/14/EC, Noise Directive, under consideration of Annex V and harmonized standard EN ISO 3744, internal combustion engine only.

Test Report:

This machine has been tested and passed the following categories prior to entering the market:

1. BRAKES: Brakes working properly in forward and reverse.
2. OVERLOAD: Overload tested at XXX% rated load.
3. FUNCTIONAL: Smooth operation at XXX% rated load.
4. FUNCTIONAL: All safety devices working correctly.
5. FUNCTIONAL: Speeds set within permitted specification.

Model / Type: <machine type>

Manufacture Date: <variable field>

Description: <machine classification>

Country of Manufacture: <variable field>

Model: <model name>

Net Installed Power: <only for IC machines>

Serial Number: <variable field>

Guaranteed Sound Power Level: <only for IC machines>

VIN: <where applicable>

Manufacturer: <Manufacturer's name>

Authorized Representative:

Genie Industries B.V
Boekerman 5,
4751 XK Oud Gastel,
The Netherlands

Empowered signatory:

Place of Issue: <variable field>

Date of Issue: <variable field>

Specifications

Contents of EC Declaration of Conformity - 2

<Manufacturer's name> hereby declares that the machinery described below complies with the provisions of the following Directives:

1. EC Directive 2006/42/EC, Machinery Directive, Conformity assessment procedure: art.12 (3) (a), with the application of European Harmonized Standard EN 280:2013+A1:2015.
2. EC Directive EMC: 2014/30/EU, under consideration of harmonized European standard EN 61000-6-2 and EN 61000-6-4
3. EC Directive 2000/14/EC, Noise Directive, under consideration of Annex V and harmonized standard EN ISO 3744, internal combustion engine only.

Test Report:

This machine has been tested and passed the following categories prior to entering the market:

1. BRAKES: Brakes working properly in forward and reverse.
2. OVERLOAD: Overload tested at XXX% rated load.
3. FUNCTIONAL: Smooth operation at XXX% rated load.
4. FUNCTIONAL: All safety devices working correctly.
5. FUNCTIONAL: Speeds set within permitted specification.

Model / Type: <machine type>

Manufacture Date: <variable field>

Description: <machine classification>

Country of Manufacture: <variable field>

Model: <model name>

Net Installed Power: <only for IC machines>

Serial Number: <variable field>

Guaranteed Sound Power Level: <only for IC machines>

VIN: <where applicable>

Manufacturer: <Manufacturer's name>

Authorized Representative:

Genie Industries B.V
Boekerman 5,
4751 XK Oud Gastel,
The Netherlands

Empowered signatory:

Place of Issue: <variable field>

Date of Issue: <variable field>



Specifications

Contents of UK Declaration of Conformity - 1

<Manufacturer's name> hereby declares that the machinery described below complies with the provisions of the following Legislation:

1. Supply of Machinery (Safety) Regulations 2008 (SI 2008/1597) as amended (SI 2011/1043, SI 2011/2157, SI 2019/696) under consideration of designated standard EN280 as described in type-examination certificate <variable field> issued by:

<notified body's name>

<notified body's number>

2. Electromagnetic Compatibility Regulations 2016 (SI 2016/1091) as amended (SI 2017/1206, SI 2019/696) under consideration of designated standard EN 61000-6-2 and EN 61000-6-4

3. Noise Emissions in the Environment by Equipment for use Outdoors Regulations 2001 (SI 2001/1701) as amended (SI 2001/3958, SI 2005/3525, 2015/98) under consideration of Annex V and designated standard EN ISO 3744, internal combustion engine only.

Test Report:

This machine has been tested and passed the following categories prior to entering the market:

1. BRAKES: Brakes working properly in forward and reverse.
2. OVERLOAD: Overload tested at XXX% rated load.
3. FUNCTIONAL: Smooth operation at XXX% rated load.
4. FUNCTIONAL: All safety devices working correctly.
5. FUNCTIONAL: Speeds set within permitted specification.

Model / Type: <machine type>

Manufacture Date: <variable field>

Description: <machine classification>

Country of Manufacture: <variable field>

Model: <model name>

Net Installed Power: <only for IC machines>

Serial Number: <variable field>

Guaranteed Sound Power Level: <only for IC machines>

VIN: <where applicable>

Manufacturer: <Manufacturer's name>

Authorized Representative:

Genie UK Ltd
The Maltings
Wharf Road
Grantham
NG31 6BH

Empowered signatory:

Place of Issue: <variable field>

Date of Issue: <variable field>



Specifications

Contents of UK Declaration of Conformity - 2

<Manufacturer's name> hereby declares that the machinery described below complies with the provisions of the following Legislation:

1. Supply of Machinery (Safety) Regulations 2008 (SI 2008/1597) as amended (SI 2011/1043, SI 2011/2157, SI 2019/696) conformity assessment procedure according to Part 3, 11. (2) (a) with reference to designated standard EN 280:2013+A1:2015
2. Electromagnetic Compatibility Regulations 2016 (SI 2016/1091) as amended (SI 2017/1206, SI 2019/696) under consideration of designated standard EN 61000-6-2 and EN 61000-6-4
3. Noise Emissions in the Environment by Equipment for use Outdoors Regulations 2001 (SI 2001/1701) as amended (SI 2001/3958, SI 2005/3525, 2015/98) under consideration of Annex V and designated standard EN ISO 3744, internal combustion engine only.

Test Report:

This machine has been tested and passed the following categories prior to entering the market:

1. BRAKES: Brakes working properly in forward and reverse.
2. OVERLOAD: Overload tested at XXX% rated load.
3. FUNCTIONAL: Smooth operation at XXX% rated load.
4. FUNCTIONAL: All safety devices working correctly.
5. FUNCTIONAL: Speeds set within permitted specification.

Model / Type: <machine type>	Manufacture Date: <variable field>
Description: <machine classification>	Country of Manufacture: <variable field>
Model: <model name>	Net Installed Power: <only for IC machines>
Serial Number: <variable field>	Guaranteed Sound Power Level: <only for IC machines>
VIN: <where applicable>	
Manufacturer: <Manufacturer's name>	Authorized Representative: Genie UK Ltd The Maltings Wharf Road Grantham NG31 6BH
Empowered signatory:	Place of Issue: <variable field>
	Date of Issue: <variable field>

www.genielift.com

Distributed By: