



Operator's Manual

GRC-12

CE

with
Maintenance
Information

First Edition
First Printing
Part No. 133136

Important

Read, understand and obey these safety rules and operating instructions before operating this machine. Only trained and authorized personnel shall be permitted to operate this machine. This manual should be considered a permanent part of your machine and should remain with the machine at all times. If you have any questions, call Genie Industries.

Contents

	Page
Introduction	1
Symbol and Hazard Pictorials Definitions	3
General Safety	5
Personal Safety	7
Work Area Safety	8
Legend	14
Controls	15
Inspections	18
Operating Instructions	28
Transport and Lifting Instructions	33
Maintenance	36
Specifications	38

Contact us:

Internet: <http://www.genielift.com>
E-mail: techpub@genieind.com

Copyright © 2008 by Genie Industries

First Edition: First Printing, August 2008

"Genie" is a registered trademark of Genie Industries in the U.S.A. and many other countries. "Runabout" and "GR" are trademarks of Genie Industries.

These machines comply with



Printed on recycled paper

Printed in U.S.A.

Introduction

Owners, Users and Operators:

Genie appreciates your choice of our machine for your application. Our number one priority is user safety, which is best achieved by our joint efforts. We feel that you make a major contribution to safety if you, as the equipment users and operators:

- 1 **Comply** with employer, job site and governmental rules.
- 2 **Read, understand and follow** the instructions in this and other manuals supplied with this machine.
- 3 **Use good safe work practices** in a commonsense way.
- 4 **Only have trained/certified operators**, directed by informed and knowledgeable supervision, running the machine.

If there is anything in this manual that is not clear or which you believe should be added, please contact us.

Internet: www.genielift.com

E-mail: techpub@genieind.com



Danger

Failure to obey the instructions and safety rules in this manual will result in death or serious injury.

Do Not Operate Unless:

- You learn and practice the principles of safe machine operation contained in this operator's manual.

1 Avoid hazardous situations.

Know and understand the safety rules before going on to the next section.

- 2 Always perform a pre-operation inspection.
- 3 Always perform function tests prior to use.
- 4 Inspect the workplace.
- 5 Only use the machine as it was intended.

- You read, understand and obey the manufacturer's instructions and safety rules—safety and operator's manuals and machine decals.
- You read, understand and obey employer's safety rules and work site regulations.
- You read, understand and obey all applicable governmental regulations.
- You are properly trained to safely operate the machine.

Introduction

Hazard Classification

Genie uses symbols, color coding and signal words to identify the following:



Safety alert symbol—used to alert you to potential personal injury hazards. Obey all safety messages that follow this symbol to avoid possible injury or death.

▲ DANGER

Red

Indicates a hazardous situation which, if not avoided, will result in death or serious injury.

▲ WARNING

Orange

Indicates a hazardous situation which, if not avoided, could result in death or serious injury.

▲ CAUTION

Yellow

Indicates a hazardous situation which, if not avoided, could result in minor or moderate injury.

NOTICE

Blue

Indicates a property damage notice.

















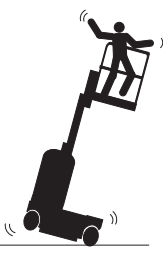

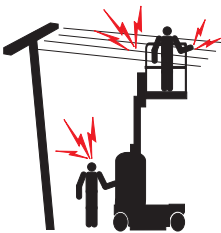

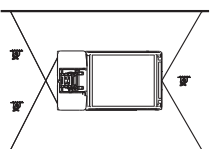

Intended Use

This machine is intended to be used only to lift personnel, along with their tools and materials to an aerial work site.

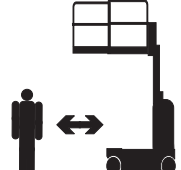

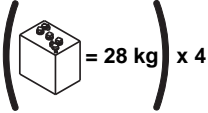
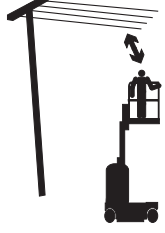



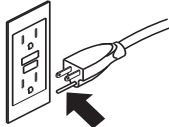

Safety Sign Maintenance

Replace any missing or damaged safety signs. Keep operator safety in mind at all times. Use mild soap and water to clean safety signs. Do not use solvent-based cleaners because they may damage the safety sign material.

Symbol and Hazard Pictorials Definitions

 <p>Read the operator's manual</p>	 <p>Read the service manual</p>	 <p>Crush hazard</p>	 <p>No smoking</p>	 <p>Collision hazard</p>
 <p>Collision hazard</p>	 <p>Tip-over hazard</p>	 <p>Tip-over hazard</p>	 <p>Use a piece of cardboard or paper to search for leaks</p>	 <p>Electrocution hazard</p>
 <p>Electrocution hazard</p>	 <p>Explosion hazard</p>	 <p>Fire hazard</p>	 <p>Burn hazard</p>	 <p>Skin injection hazard</p>
 <p>Transport diagram</p>	 <p>Tiedown</p>	 <p>Keep away from moving parts</p>	 <p>Move machine to level ground</p>	 <p>Batteries used as counterweights</p>
 <p>Maintain required clearance</p>	 <p>Only trained maintenance personnel should access compartments</p>	 <p>Chock the wheels</p>	 <p>Release brakes</p>	 <p>Grounded AC 3-wire only</p>

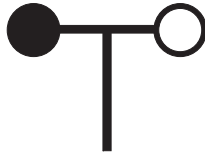
Symbol and Hazard Pictorials Definitions

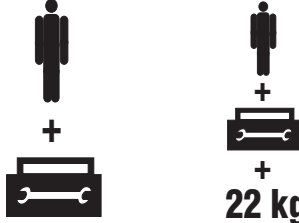
 <p>Replace damaged wires and cords</p>	 <p>Wheel load</p>	 <p>Side force</p>	 <p>Lanyard attachment point</p>	 <p>Voltage rating for power to platform</p>
 <p>Pressure rating for air line to platform</p>	 <p>Wind speed</p>	 <p>Indoor</p>		
 <p>Maximum capacity including occupant</p>		 <p>Maximum capacity including occupant, tools and tray</p>		

General Safety

Safety signs and locations Decals with symbols

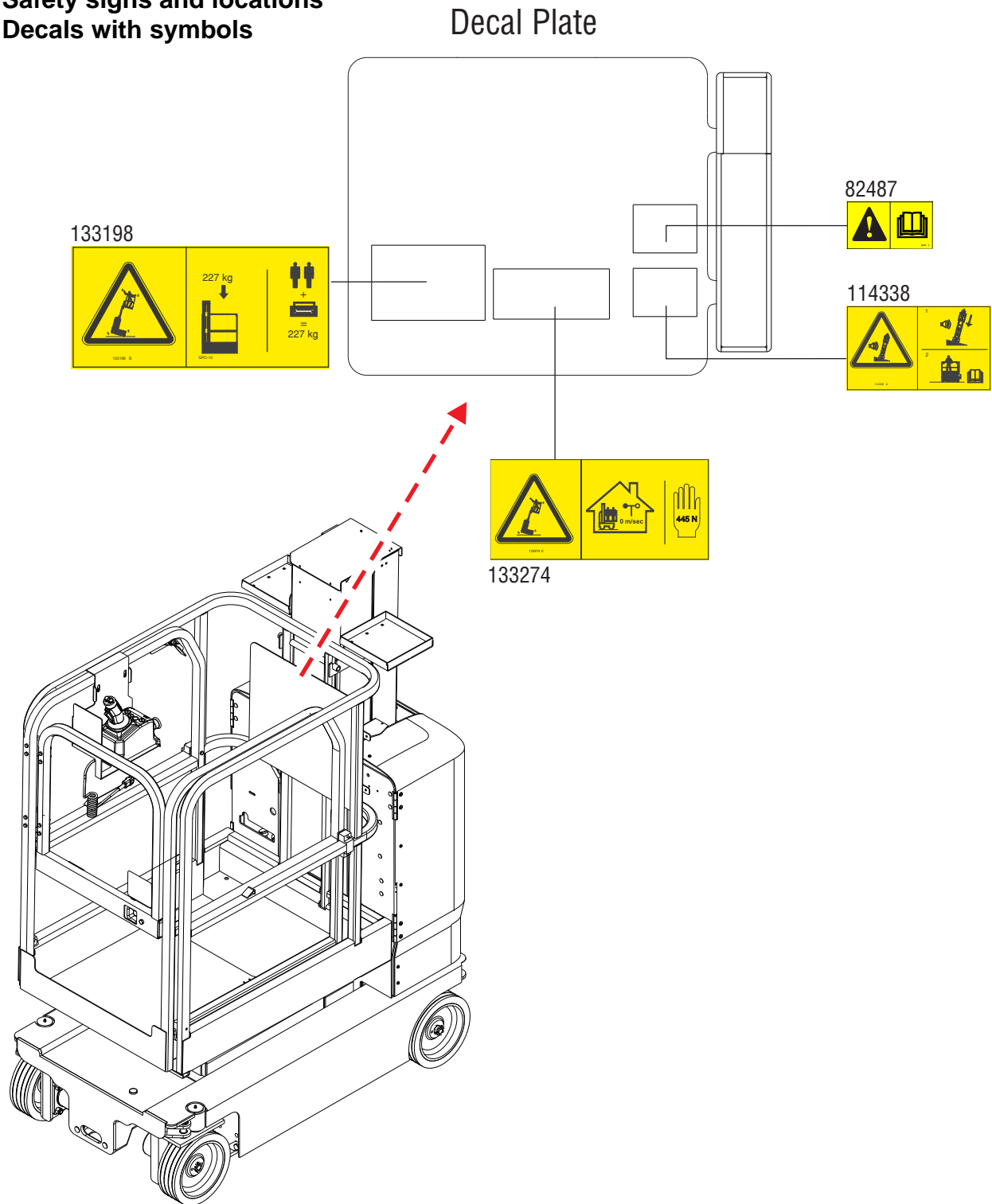

Personal Safety

Fall Protection

Personal fall protection equipment (PFPE) is not required when operating this machine. If PFPE is required by job site or employer rules, the following shall apply:

All PFPE must comply with applicable governmental regulations, and must be inspected and used in accordance with the PFPE manufacturer's instructions.

Work Area Safety

⚠️ Electrocutation Hazards



This machine is not electrically insulated and will not provide protection from contact with or proximity to electrical current.



Maintain safe distances from electrical power lines and apparatus in accordance with applicable governmental regulations and the following chart.

Line Voltage	Required Clearance
0 to 50KV	3.05 m
50KV to 200KV	4.60 m
200KV to 350KV	6.10 m
350KV to 500KV	7.62 m
500KV to 750KV	10.67 m
750KV to 1000KV	13.72 m

Allow for platform movement, electrical line sway or sag and beware of strong or gusty winds.

Keep away from the machine if it contacts energized power lines. Personnel on the ground or in the platform must not touch or operate the machine until energized power lines are shut off.

Do not operate the machine during lightning or storms.

Do not use the machine as a ground for welding.

⚠️ Tip-over Hazards

Occupants, equipment and materials must not exceed the maximum platform capacity or the maximum capacity of the platform extension. Weight in trays is part of the total platform load.

Maximum capacity - GRC-12

Platform retracted	227 kg
Work station tray (each)	11 kg
Maximum occupants	2



Do not raise the platform unless the machine is on a firm, level surface.



Do not depend on the tilt alarm as a level indicator. The tilt alarm sounds inside the battery charger tray only when the machine is on a severe slope.

Work Area Safety

If the tilt alarm sounds:

Lower the platform. Move the machine to a firm, level surface. If the tilt alarm sounds when the platform is raised, use extreme caution to lower the platform.

Do not drive over 0.8 km/h with the platform raised.

When raising the platform, follow rating for allowable manual force and number of occupants in the next column.



Do not operate the machine in strong or gusty winds. Do not increase the surface area of the platform or the load. Increasing the area exposed to the wind will decrease machine stability.

Use extreme care and slow speeds while driving the machine in a stowed position across uneven terrain, debris, unstable or slippery surfaces and near holes and drop-offs.



Do not drive the machine on or near uneven terrain, unstable surfaces or other hazardous conditions with the platform raised.

Do not use the machine as a crane.

Do not push the machine or other objects with the platform.

Do not contact adjacent structures with the platform.

Do not tie the platform to adjacent structures.

Do not place loads outside the platform perimeter.

Do not use the platform controls to free a platform that is caught, snagged or otherwise prevented from normal motion by an adjacent structure. All personnel must be removed from the platform before attempting to free the platform using the ground controls.



Do not push off or pull toward any object outside of the platform.

Model	Maximum allowable manual force	Maximum number of occupants
CE	445 N	Indoor only - 2

Do not alter or disable the limit switches.

Do not alter or disable machine components that in any way affect safety and stability.

Do not replace items critical to machine stability with items of different weight or specification.

Work Area Safety

Do not use batteries that weigh less than the original equipment. Batteries are used as counterweight and are critical to machine stability. Each battery must weigh 28 kg.

Do not modify or alter an aerial work platform without prior written permission from the manufacturer. Mounting attachments for holding tools or other materials onto the platform, toeboards or guard rail system can increase the weight in the platform and the surface area of the platform or the load.



Do not place or attach fixed or overhanging loads to any part of this machine.

Do not place ladders or scaffolds in the platform or against any part of this machine.



Do not transport tools and materials unless they are evenly distributed and can be safely handled by the person in the platform.

Do not use the machine on a moving or mobile surface or vehicle.



Be sure all tires are in good condition, castle nuts are properly tightened and cotter pins are properly installed.

⚠️ Crushing Hazard

Keep hands and limbs out of mast.

Do not work under the platform or mast without the battery cover raised.

Use common sense and planning when operating the machine with the controller from the ground. Maintain safe distances between the operator, the machine and fixed objects.

⚠️ Operation on Slopes Hazards

Do not drive the machine on a slope that exceeds the slope and side slope rating of the machine. Slope rating applies to machines in the stowed position only.



Maximum slope rating, stowed position	30% (17°)
--	-----------



Maximum side slope rating, stowed position	30% (17°)
---	-----------

Note: Slope rating is subject to ground conditions and adequate traction.

⚠️ Fall Hazards

The guard rail system provides fall protection. If the occupant of the platform is required to wear personal fall protection equipment (PFPE) due to job site or employer rules, PFPE and its use shall be in accordance with the PFPE manufacturer's instructions and applicable governmental requirements. Use approved lanyard attachment point provided.

Work Area Safety

Keep the platform floor clear of debris.

Close the entry gate before operating.



Do not sit, stand or climb on the platform guard rails. Maintain a firm footing on the platform floor at all times.



Do not climb down from the platform when raised.

⚠ Collision Hazards



Be aware of limited sight distance and blind spots when driving or operating.

Be aware of the extended platform position when moving the machine.

The machine must be on a level surface or secured before releasing the brakes.



Check the work area for overhead obstructions or other possible hazards.

Be aware of crushing hazards when grasping the platform guard rail.



Operators must comply with employer, job site and governmental rules regarding use of personal protective equipment.

Do not lower the platform unless the area below is clear of personnel and obstructions.



Limit travel speed according to the condition of the ground surface, congestion, slope, location of personnel, and any other factors which may cause collision.



Do not operate a machine in the path of any crane or moving overhead machinery unless the controls of the crane have been locked out and/or precautions have been taken to prevent any potential collision.

No stunt driving or horseplay while operating a machine.

Work Area Safety

⚠ Bodily Injury Hazard

Do not operate the machine with a hydraulic oil or air leak. An air leak or hydraulic leak can penetrate and/or burn skin.

Improper contact with components under any cover will cause serious injury. Only trained maintenance personnel should access compartments. Access by the operator is only advised when performing a pre-operation inspection. All compartments must remain closed and secured during operation.

⚠ Explosion and Fire Hazards

Do not operate the machine or charge the battery in hazardous locations or locations where potentially flammable or explosive gases or particles may be present.

⚠ Damaged Machine Hazards

Do not use a damaged or malfunctioning machine.

Conduct a thorough pre-operation inspection of the machine and test all functions before each work shift. Immediately tag and remove from service a damaged or malfunctioning machine.

Be sure all maintenance has been performed as specified in this manual and the appropriate service manual.

Be sure all decals are in place and legible.

Be sure the operator's, safety, and responsibilities manuals are complete, legible and in the storage container located on the platform.

⚠ Component Damage Hazards

Do not use any battery charger greater than 24V to charge the batteries.

Do not use the machine as a ground for welding.

Work Area Safety

⚠ Battery Safety

Burn Hazards



Batteries contain acid. Always wear protective clothing and eye wear when working with batteries.

Avoid spilling or contacting battery acid. Neutralize battery acid spills with baking soda and water.

Do not expose the batteries or the charger to water or rain during charging.

Explosion Hazards



Keep sparks, flames and lighted tobacco away from batteries. Batteries emit an explosive gas.



The battery tray should remain open during the entire charging cycle.



Do not contact the battery terminals or the cable clamps with tools that may cause sparks.

Component Damage Hazard

Do not use any battery charger greater than 24V to charge the batteries.

Electrocution/Burn Hazards



Connect the battery charger to a grounded, AC 3-wire electrical outlet only.

Inspect daily for damaged cords, cables and wires. Replace damaged items before operating.

Avoid electrical shock/burns from contact with battery terminals. Remove all rings, watches and other jewelry.

Tip-over Hazard

Do not use batteries that weigh less than the original equipment. Batteries are used as counterweight and are critical to machine stability. Each battery must weigh 28 kg.

Lifting Hazard

Use the appropriate number of people and proper lifting techniques when lifting batteries.

Lockout After Each Use

- 1 Select a safe parking location—firm level surface, clear of obstruction and traffic.
- 2 Lower the platform.
- 3 Turn the key switch to the off position and remove the key to secure from unauthorized use.
- 4 Chock the wheels.
- 5 Charge the batteries.

Legend

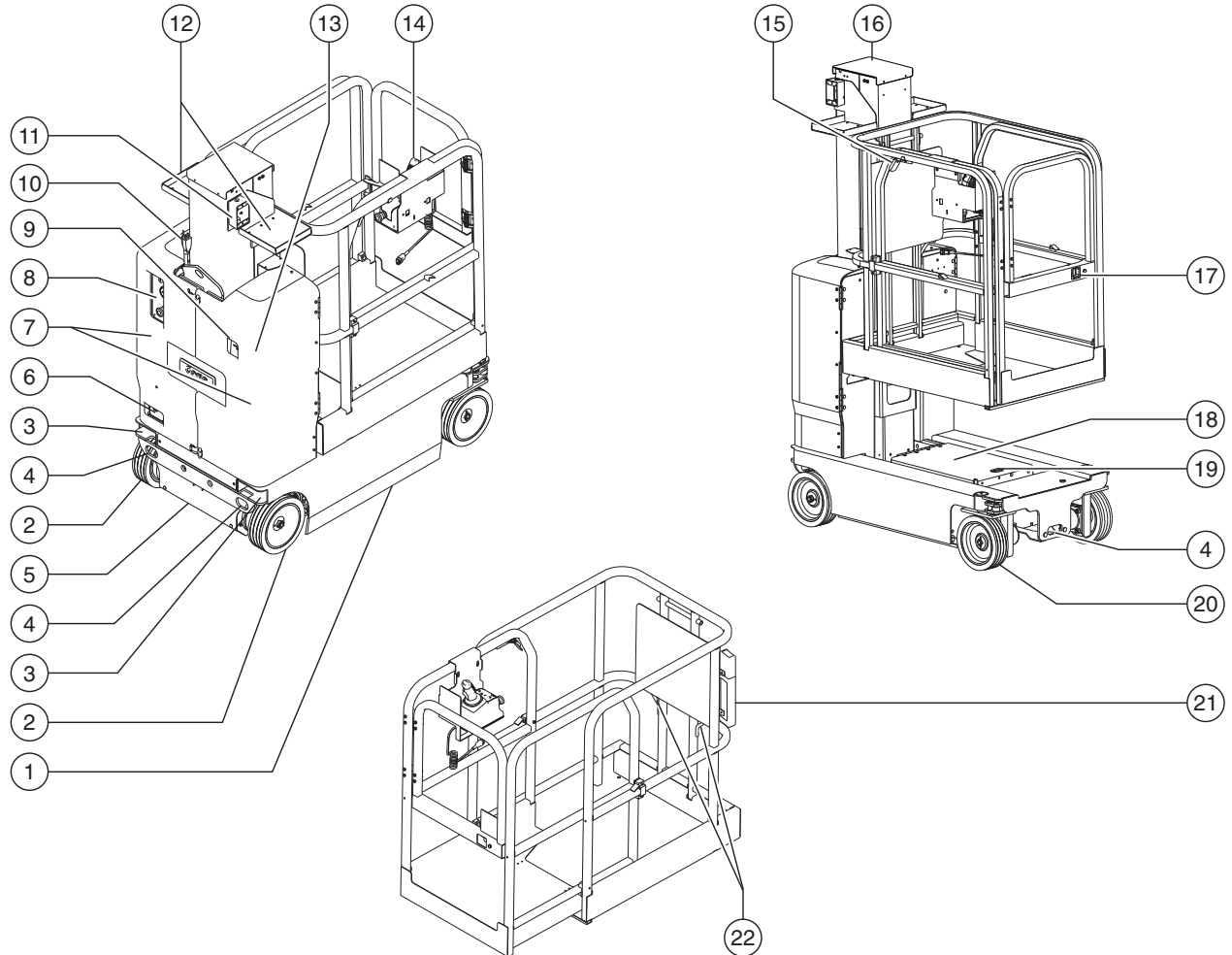

- 1 Pothole guard
- 2 Non-steer tire
- 3 Forklift pocket
- 4 Transport tie-down
- 5 Emergency lowering valve
- 6 Battery charger display
- 7 Covers
- 8 Ground controls
- 9 Hydraulic oil level indicator

- 10 Power to platform/battery charger connection for optional inverter
- 11 GFCI outlet
- 12 Work station tray
- 13 Brake release pump knob (under covers)
- 14 Platform controls
- 15 Platform extension release lever
- 16 Mast

- 17 Platform extension entry gate
- 18 Battery compartment cover
- 19 Battery cover latch
- 20 Steer tire
- 21 Manual storage container
- 22 Lanyard anchorage point

Controls

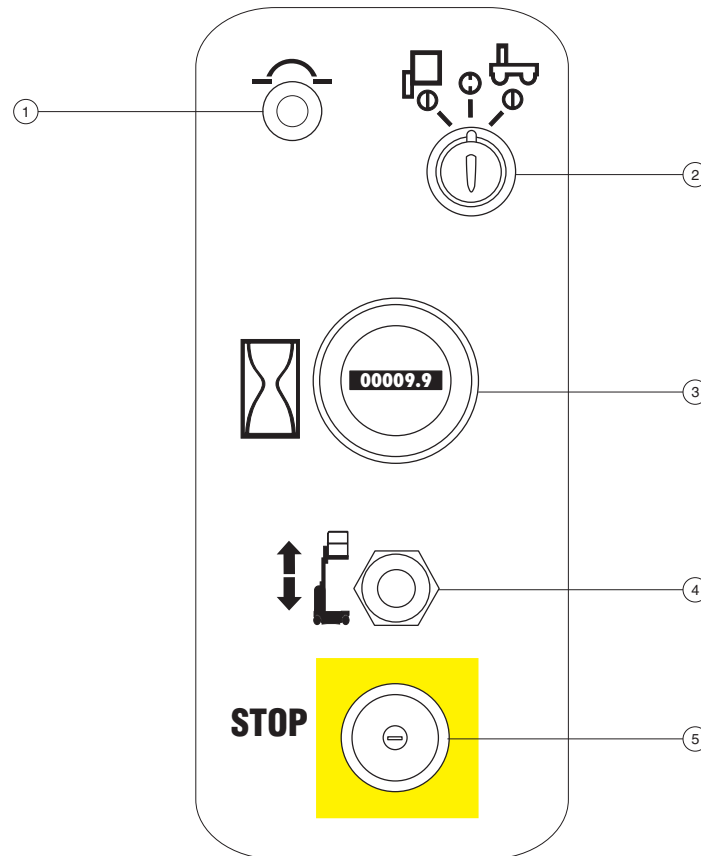

Ground Control Panel

- 1 7 amp breaker for electric circuits
- 2 Key switch for platform/off/ground selection
Turn the key switch to the platform position and the platform controls will operate. Turn the key switch to the off position and the machine will be off. Turn the key switch to the base position and the ground controls will operate.
- 3 Hour meter
Indicates the number of hours the machine has been put into use.

- 4 Platform up/down toggle switch
Move the switch up and the platform will raise. Move the switch down and the platform will lower.
- 5 Red Emergency Stop button
Push in the red Emergency Stop button to the off position to stop all functions. Pull out the red Emergency Stop button to the on position to operate the machine.



Controls

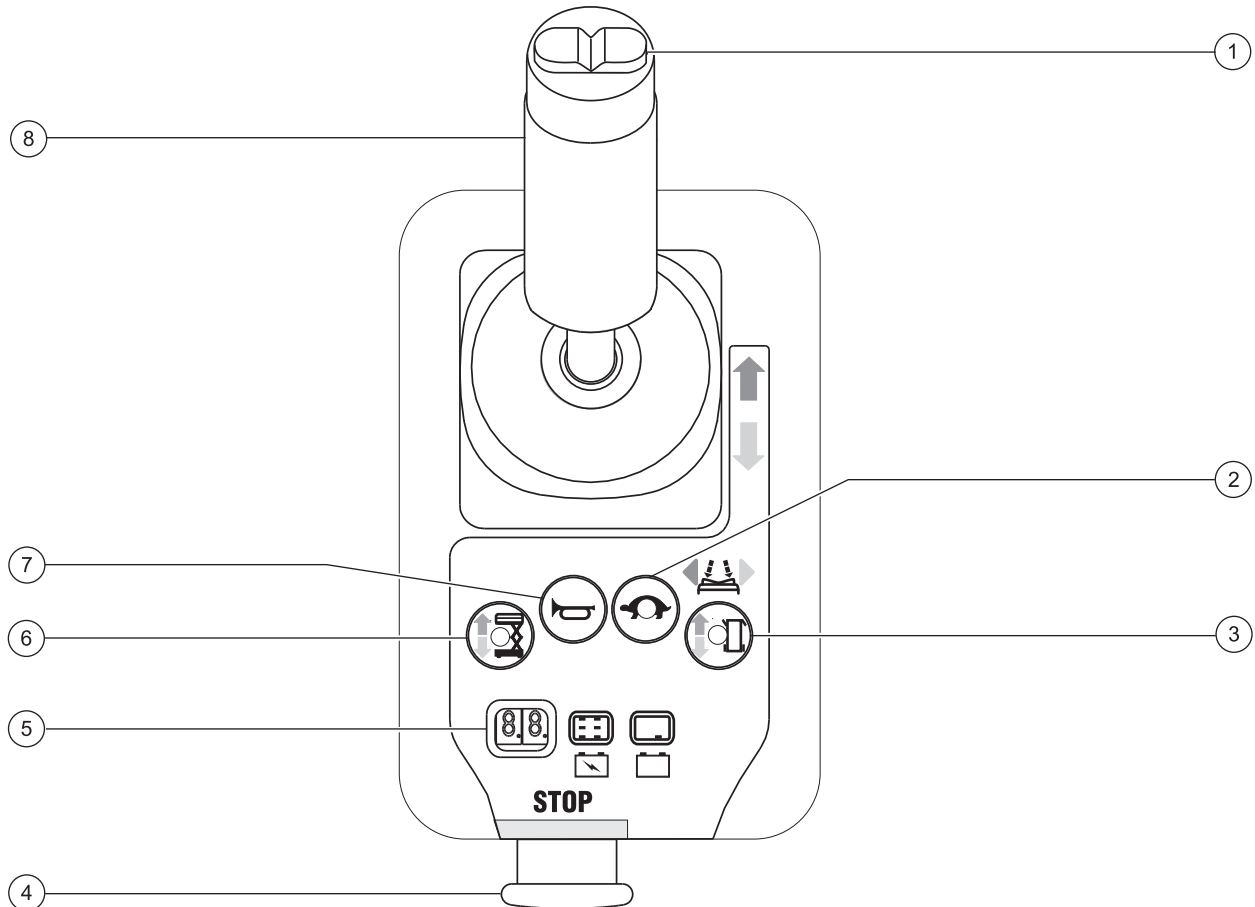

Platform Control Panel

- | | |
|---|---|
| 1 Thumb rocker switch for steer functions | 5 LED diagnostic readout / Platform overload indicator / Battery charge indicator |
| 2 Drive speed button | 6 Lift function select button |
| 3 Drive function select button | 7 Horn button |
| 4 Red Emergency Stop button | 8 Proportional control handle and function enable switch for lift and drive functions |

Controls

Platform Control Panel

- 1 Thumb rocker switch for steer functions

Press the thumb rocker switch in either direction to activate the steer function.

- 2 Drive speed button

Press this button to activate slow drive function. The indicator light will be on when slow drive is selected.

- 3 Drive function select button

Press this button to activate the drive function.



- 4 Red Emergency Stop button

Push in the red Emergency Stop button to the off position to stop all functions. Pull out the red Emergency Stop button to the on position to operate the machine.

- 5 LED

Diagnostic read out, platform overload indicator, battery charge indicator.

- 6 Lift function select button

Press this button to activate the lift function.



- 7 Horn Button

Push the horn button and the horn will sound. Release the horn button and the horn will stop.

- 8 Proportional control handle and function enable switch for lift and drive functions

Lift function: Press and hold the function enable switch to enable the lift function on the platform control handle. Move the control handle in the direction indicated by the blue arrow and the platform will raise. Move the control handle in the direction indicated by the yellow arrow and the platform will lower. The descent alarm should sound while the platform is lowering.

Drive function: Press and hold the function enable switch to enable the drive function on the platform control handle. Move the control handle in the direction indicated by the blue arrow on the platform entry gate and the machine will move in the direction that the blue arrow points. Move the control handle in the direction indicated by the yellow arrow on the platform entry gate and the machine will move in the direction that the yellow arrow points.

Inspections



Do Not Operate Unless:

- You learn and practice the principles of safe machine operation contained in this operator's manual.
 - 1 Avoid hazardous situations.
 - 2 Always perform a pre-operation inspection.**
- Know and understand the pre-operation inspection before going on to the next section.**
- 3 Always perform function tests prior to use.
- 4 Inspect the workplace.
- 5 Only use the machine as it was intended.

Pre-operation Inspection Fundamentals

It is the responsibility of the operator to perform a pre-operation inspection and routine maintenance.

The pre-operation inspection is a visual inspection performed by the operator prior to each work shift. The inspection is designed to discover if anything is apparently wrong with a machine before the operator performs the function tests.

The pre-operation inspection also serves to determine if routine maintenance procedures are required. Only routine maintenance items specified in this manual may be performed by the operator.

Refer to the list on the next page and check each of the items.

If damage or any unauthorized variation from factory delivered condition is discovered, the machine must be tagged and removed from service.

Repairs to the machine may only be made by a qualified service technician, according to the manufacturer's specifications. After repairs are completed, the operator must perform a pre-operation inspection again before going on to the function tests.

Scheduled maintenance inspections shall be performed by qualified service technicians, according to the manufacturer's specifications and the requirements listed in the responsibilities manual.

Inspections

Pre-operation Inspection

- Be sure that the operator's, safety and responsibilities manuals are complete, legible and in the storage container located on the platform.
- Be sure that all decals are legible and in place. See Inspections section.
- Check for hydraulic oil leaks and proper oil level. Add oil if needed. See Maintenance section.
- Check for battery fluid leaks and proper fluid level. Add distilled water if needed. See Maintenance section.

Check the following components or areas for damage, improperly installed or missing parts and unauthorized modifications:

- Electrical components, wiring and electrical cables
- Hydraulic power unit, tank, hoses, fittings, cylinders and manifolds
- Battery pack and connections
- Drive motors
- Tires and wheels
- Ground strap
- Limit switches, alarms and horn
- Alarms and beacons (if equipped)
- Nuts, bolts and other fasteners
- Platform entry gate
- Sequencing cables and pulleys
- Pothole guards
- Platform extension
- Work trays

- Brake release components
- Battery cover
- Mast columns and counterweight
- Platform control joystick

Check the entire machine for:

- Cracks in welds or structural components
- Dents or damage to the machine
- Excessive rust, corrosion or oxidation
- Be sure that all structural and other critical components are present and all associated fasteners and pins are in place and properly tightened.

Note: If the platform must be raised to inspect the machine, make sure the battery cover is in place. See Operating Instructions section.

Inspections



Do Not Operate Unless:

- You learn and practice the principles of safe machine operation contained in this operator's manual.

- 1 Avoid hazardous situations.
- 2 Always perform a pre-operation inspection.

3 Always perform function tests prior to use.

Know and understand the function tests before going on to the next section.

- 4 Inspect the workplace.
- 5 Only use the machine as it was intended.

Function Test Fundamentals

The function tests are designed to discover any malfunctions before the machine is put into service. The operator must follow the step-by-step instructions to test all machine functions.

A malfunctioning machine must never be used. If malfunctions are discovered, the machine must be tagged and removed from service. Repairs to the machine may only be made by a qualified service technician, according to the manufacturer's specifications.

After repairs are completed, the operator must perform a pre-operation inspection and function tests again before putting the machine into service.

Inspections

- 1 Select a test area that is firm, level and free of obstruction.
- 2 Be sure the batteries are connected.

At the Ground Controls

- 3 Pull out the platform and ground red Emergency Stop buttons to the on position.
- 4 Turn the key switch to ground control.
- 5 Observe the diagnostic LED readout on the platform controls.

- ⦿ Result: The LED should look like the picture at right.



Test Emergency Stop

- 6 Push in the ground red Emergency Stop button to the off position.
- ⦿ Result: No functions should operate.
- 7 Pull out the red Emergency Stop button to the on position.

Test the Up/Down Functions

The audible warnings on this machine and the standard horn all come from the same central alarm. The horn is a constant tone. The descent alarm sounds at 60 beeps per minute. The alarm that goes off when the pothole guards have not deployed sounds at 300 beeps per minute. The alarm that goes off when the machine is not level sounds at 600 beeps per minute. An optional automotive-style horn is also available.

- 8 Activate the up function.
- ⦿ Result: The platform should raise.

- 9 Activate the down function.

- ⦿ Result: The platform should lower. The descent alarm should sound while the platform is lowering.

Test Emergency Lowering

- 10 Activate the up function and raise the platform approximately 60 cm.

- 11 Pull the Emergency lowering knob located at the base of the machine below the mast.

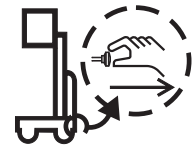

- ⦿ Result: The platform should lower. The descent alarm will not sound.

- 12 Turn the key switch to platform control.

At the Platform Controls

Test Emergency Stop

- 13 Push in the platform red Emergency Stop button to the off position.
- ⦿ Result: No functions should operate.

Test the Horn

- 14 Pull out the red Emergency Stop button to the on position.
 - 15 Push the horn button.
- ⦿ Result: The horn should sound.

Inspections

Test the Function Enable Switch

- 16 Do not hold the function enable switch on the control handle.
 - 17 Slowly move the control handle in the direction indicated by the blue arrow, then in the direction indicated by the yellow arrow.
- ⦿ Result: No functions should operate.

Test the Up/Down Functions

- 18 Press the lift function select button.
 - 19 Press and hold the function enable switch on the control handle.
 - 20 Slowly move the control handle in the direction indicated by the blue arrow.
- ⦿ Result: The platform should raise. The pothole guards should deploy.
- 21 Release the control handle.
- ⦿ Result: The platform should stop raising.
- 22 Press and hold the function enable switch. Slowly move the control handle in the direction indicated by the yellow arrow.
- ⦿ Result: The platform should lower. The descent alarm should sound while the platform is lowering.



When lowering the platform, the platform should stop when it is approximately 2.1 m from the ground. Be sure the area below the platform is clear of personnel and obstructions before continuing. To continue lowering, release the control handle, wait 5 seconds, then move the control handle again.

Test the Steering

Note: When performing the steer and drive function tests, stand in the platform facing the steer end of the machine.

- 23 Press the drive function select switch.
 - 24 Press and hold the function enable switch on the control handle.
 - 25 Depress the thumb rocker switch on top of the control handle in the direction indicated by the blue triangle on the control panel.
- ⦿ Result: The steer wheels should turn in the direction that the blue triangle points on the control panel.
- 26 Depress the thumb rocker switch in the direction indicated by the yellow triangle on the control panel.
- ⦿ Result: The steer wheels should turn in the direction that the yellow triangle points on the control panel.

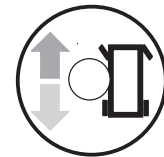

Inspections

Test Drive and Braking

- 27 Press and hold the function enable switch.
- 28 Slowly move the control handle in the direction indicated by the blue arrow on the control panel until the machine begins to move, then return the handle to the center position.
- ⦿ Result: The machine should move in the direction that the blue arrow points on the control panel, then come to an abrupt stop.
- 29 Slowly move the control handle in the direction indicated by the yellow arrow on the control panel until the machine begins to move, then return the handle to the center position.
- ⦿ Result: The machine should move in the direction that the yellow arrow points on the control panel, then come to an abrupt stop.

Note: The brakes must be able to hold the machine on any slope it is able to climb.

Test the Tilt Sensor

- 30 Locate the tilt sensor located above the ground controls panel behind the ground controls cover.
- 31 Press down one side of the tilt sensor and place the tilt sensor test tool under one of the posts.
- ⦿ Result: The alarm, located in the platform, should sound after 1 second.

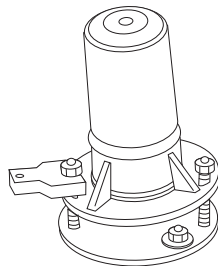

- 32 Test all ground and platform control functions.

- ⦿ Result: Before the platform is raised approximately 30 cm, the lift function should stop, an alarm should sound and the LED readout should display LL.

- 33 Remove the tilt sensor test tool.

- 34 Turn the key switch to platform control.

Test Limited Drive Speed

- 35 Press the lift function select button.
- 36 Press and hold the function enable switch on the control handle. Raise the platform approximately 60 cm from the ground.
- 37 Press the drive function select button.
- 38 Press and hold the function enable switch on the control handle. Slowly move the control handle to the full drive position.

- ⦿ Result: The maximum achievable drive speed with the platform raised should not exceed 20 cm per second.

If the drive speed with the platform raised exceeds 20 cm per second, immediately tag and remove the machine from service.

Inspections

Test the Pothole Guards

Note: The pothole guards should automatically deploy when the platform is raised. The pothole guards activate another limit switch which allows the machine to continue to function. If the pothole guards do not deploy, an alarm sounds and the machine will not drive.

39 Raise the platform.

- ⦿ Result: When the platform is raised 1.2 m from the ground, the pothole guards should deploy.

40 Press on the pothole guards on one side, and then the other.

- ⦿ Result: The pothole guards should not move.

41 Lower the platform.

- ⦿ Result: The pothole guards should return to the stowed position.

42 Place a 2x4 or similar piece of wood under a pothole guard. Raise the platform.

- ⦿ Result: Before the platform is raised 2.1 m from the ground, an alarm should sound and the drive function should not work.

43 Lower the platform and remove the 2x4.

Inspections



Do Not Operate Unless:

- You learn and practice the principles of safe machine operation contained in this operator's manual.

- 1 Avoid hazardous situations.
- 2 Always perform a pre-operation inspection.
- 3 Always perform function tests prior to use.

4 Inspect the workplace.

Know and understand the workplace inspection before going on to the next section.

- 5 Only use the machine as it was intended.

Fundamentals

The workplace inspection helps the operator determine if the workplace is suitable for safe machine operation. It should be performed by the operator prior to moving the machine to the workplace.

It is the operator's responsibility to read and remember the workplace hazards, then watch for and avoid them while moving, setting up and operating the machine.

Workplace Inspection

Be aware of and avoid the following hazardous situations:

- drop-offs or holes
- bumps, floor obstructions or debris
- sloped surfaces
- unstable or slippery surfaces
- overhead obstructions and high voltage conductors
- hazardous locations
- inadequate surface support to withstand all load forces imposed by the machine
- wind and weather conditions
- the presence of unauthorized personnel
- other possible unsafe conditions

Inspections

Inspection for Decals with Symbols

Determine whether the decals on your machine have words or symbols. Use the appropriate inspection to verify that all decals are legible and in place.

Part No.	Description	Quantity
28174	Label - Power to Platform, 230V	2
28235	Label - Power to Platform, 115V	2
40434	Label - Lanyard Anchorage	2
43658	Label - Power to Charger, 230V	1
44980	Label - Power to Charger, 115V	1
52475	Label - Transport Tie-down	3
72188	Label - Directional Arrows	2
82472	Label - Crushing Hazard	2
82473	Label - Compartment Access	1
82481	Label - Battery Safety	1
82487	Label - Read the Manual	2
82495	Label - Brake Release Safety and Operation	1
82614	Label - Collision Hazard	1
82666	Label - Forklift Pocket	2
82836	Label - Emergency Lowering	1
97772	Platform Control Panel	1

Part No.	Description	Quantity
97899	Label - Safety Chock	1
114334	Label - Electrocution Hazard, Plug	1
114338	Label - Tip-over Hazard, Tilt Alarm	1
114467	Cosmetic - Grey Stripe, Left Side	1
114468	Cosmetic - Grey Stripe, Right Side	1
114469	Ground Control Panel	1
133015	Label - Electrocution Hazard	1
133144	Label - Transport Diagram	2
133146	Label - Tip-over Hazard, Batteries	1
133147	Label - Tip-over Hazard, Limit Switch	1
133194	Label - Wheel Load, GRC-12	4
133195	Cosmetic - Genie GRC-12	2
133198	Label - Max Capacity, 227 kg, GRC-12	1
133237	Cosmetic - Genie Runabout Contractor	2
133274	Label - Max Manual Force, 445 N, CE	1
133280	Label - Max Capacity, Work Station Tray, 11 kg (each)	2

Inspections

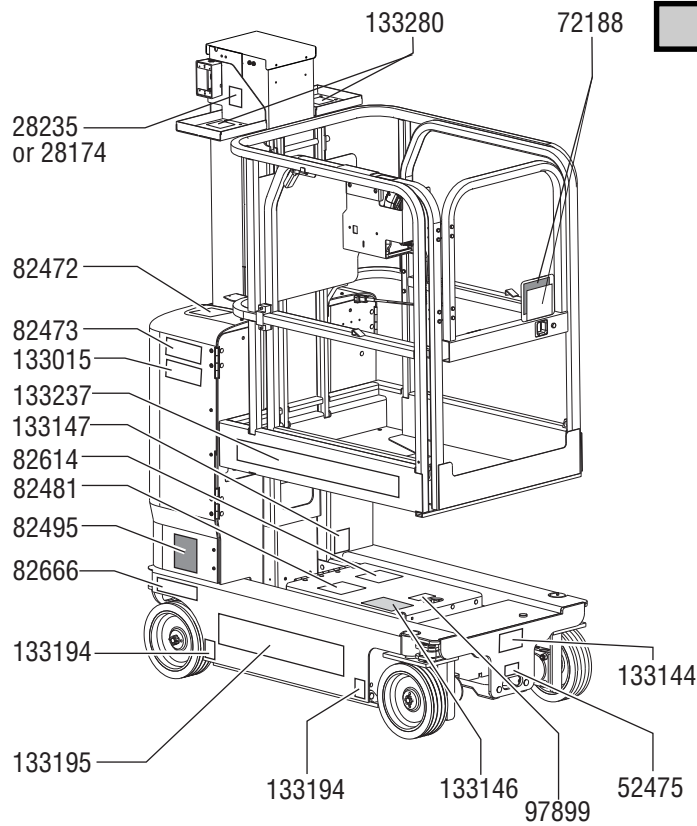

Shading indicates decal is hidden from view, i.e., under covers.

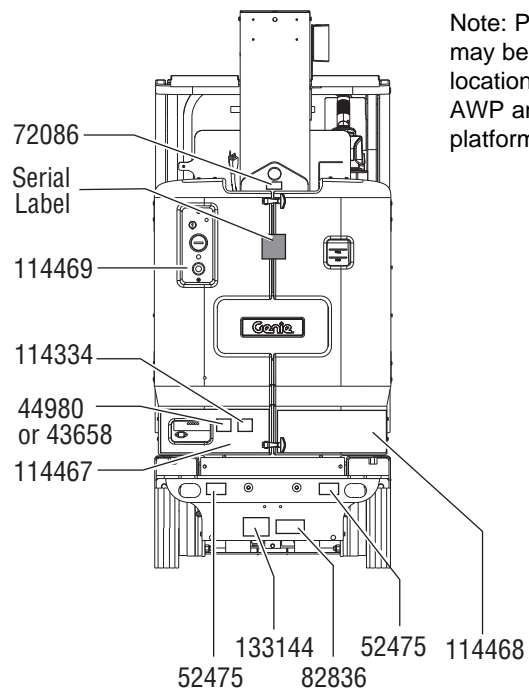
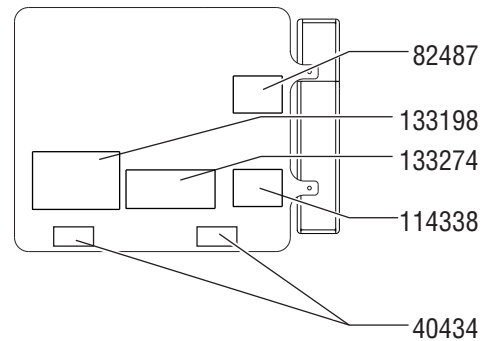

Note: Platform decals may be in different locations on optional AWP and fiberglass platform.

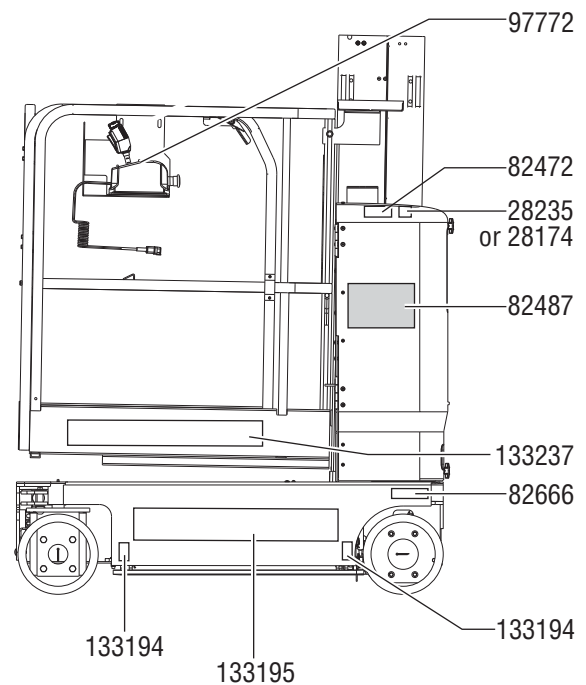

Operating Instructions



Do Not Operate Unless:

- You learn and practice the principles of safe machine operation contained in this operator's manual.
 - 1 Avoid hazardous situations.
 - 2 Always perform a pre-operation inspection.
 - 3 Always perform function tests prior to use.
 - 4 Inspect the workplace.
 - 5 Only use the machine as it was intended.**

Fundamentals

The Operating Instructions section provides instructions for each aspect of machine operation. It is the operator's responsibility to follow all the safety rules and instructions in the operator's, safety and responsibilities manuals.

Using the machine for anything other than lifting personnel, along with their tools and materials, to an aerial work site is unsafe and dangerous.

Only trained and authorized personnel should be permitted to operate a machine. If more than one operator is expected to use a machine at different times in the same work shift, they must all be qualified operators and are all expected to follow all safety rules and instructions in the operator's, safety and responsibilities manuals. That means every new operator should perform a pre-operation inspection, function tests, and a workplace inspection before using the machine.

Operating Instructions

Emergency Stop

Push in the red Emergency Stop button to the off position at the ground or platform controls to stop all functions.

Repair any function that operates when either red Emergency Stop button is pushed in.

Emergency Lowering

- 1 Pull the Emergency lowering knob.

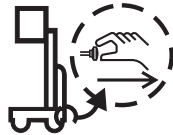

Operation From Ground

- 1 Turn the key switch to ground control.
- 2 Pull out both ground and platform red Emergency Stop buttons to the on position.
- 3 Be sure the battery pack is connected before operating the machine.

To Position Platform

- 1 Move the up/down toggle switch according to the markings on the control panel.

Drive and steer functions are not available from the ground controls.

Operation From Platform

- 1 Turn the key switch to platform control.
- 2 Pull out the ground and platform red Emergency Stop buttons to the on position.
- 3 Be sure the battery pack is connected before operating the machine.

To Position Platform

- 1 Press the lift function select button.
- 2 Press and hold the function enable switch on the control handle.
- 3 Move the control handle according to the markings on the control panel.



To Steer

- 1 Press the drive function select button.
- 2 Press and hold the function enable switch on the control handle.
- 3 Turn the steer wheels with the thumb rocker switch located on the top of the control handle.

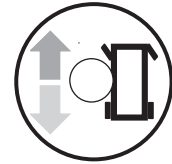

To Drive

- 1 Press the drive function select button.
- 2 Press and hold the function enable switch on the control handle.
- 3 Increase speed: Slowly move the control handle off center.
Decrease speed: Slowly move the control handle toward center.
Stop: Return the control handle to center or release the function enable switch.

Use the color-coded direction arrows on the platform controls and on the platform to identify the direction the machine will travel.

Operating Instructions

Machine travel speed is restricted when the platform is raised.

Battery condition will affect machine performance. Machine drive speed and function speed will drop when the battery level indicator is flashing.

To Reduce Drive Speed

The drive controls can operate in two different drive speed modes. When the drive speed button light is on, slow drive speed mode is active. When the button light is off, fast drive speed mode is active.

Press the drive speed button to select the desired drive speed.

Driving on a slope

Determine the slope and side slope ratings for the machine and determine the slope grade.



Maximum slope rating, stowed	30% (17°)
-------------------------------------	-----------



Maximum side slope rating, stowed	30% (17°)
--	-----------

Note: Slope rating is subject to ground conditions and adequate traction.

Press the drive speed button to the fast drive speed mode.

To determine the slope grade:

Measure the slope with a digital inclinometer OR use the following procedure.

You will need:

- carpenter's level
- straight piece of wood, at least 1 m long
- tape measure

Lay the piece of wood on the slope.

At the downhill end, lay the level on the top edge of the piece of wood and lift the end until the piece of wood is level.

While holding the piece of wood level, measure the distance from the bottom of the piece of wood to the ground.

Divide the tape measure distance (rise) by the length of the piece of wood (run) and multiply by 100.

Example:



Run = 3.6 m

Rise = 0.3 m

$$0.3 \text{ m} \div 3.6 \text{ m} = 0.083 \times 100 = 8.3\% \text{ grade}$$

If the slope exceeds the maximum slope or side slope rating, the machine must be winched or transported up or down the slope. See Transport and Lifting section.

Operating Instructions

Error indicator readout



If the LED diagnostic readout displays an error code, such as LL, push in and pull out the red Emergency Stop button to reset the system.

ECM Fault Codes

Code	Condition
--	Condition Normal
01	Internal ECM Error
02	ECM/Platform Communication Error
03	Undefined Platform Dip Switch Setting
12	Chassis Up/Down Toggle Closed At Startup
18	Pothole Guard Failure
42	Platform Left Turn Switch Fault
43	Platform Right Turn Switch Fault
46	Platform Drive Enable Switch Fault
47	Platform Joystick Fault
52	Forward Coil Fault
53	Reverse Coil Fault
54	Up Coil Fault
55	Down Coil Fault
56	Right Coil Fault
57	Left Coil Fault
58	Brake Coil Fault
59	Parallel/Series Coil Fault
68	Low Battery Voltage
LL	Off-Level
OL	Overload Cutout Option

For more information, please consult the appropriate Genie Service Manual.

To Extend and Retract Platform

- 1 Press and hold extension release lever.
- 2 Grasp the platform guard rails carefully and push to extend the platform until locked.

Operation From Ground with Platform Controller

Maintain safe distances between the operator, machine and fixed objects.

Be aware of the direction the machine will travel when using the controller.

Platform Overload

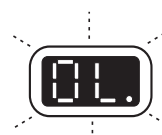

Flashing OL in the LED diagnostic readout indicates the platform is overloaded and no functions will operate. An alarm will sound.

- 1 Push in the Red Emergency stop button to the off position.
- 2 Remove weight from the platform.
- 3 Pull out the Red Emergency stop button to the on position.

Battery Level Indicator



Use the LED diagnostic readout to determine the battery level.

Operating Instructions



Battery and Charger Instructions

Observe and Obey:

- Do not use an external charger or booster battery.
- Charge the battery in a well-ventilated area.
- Use proper AC input voltage for charging as indicated on the charger.
- Use only a Genie authorized battery and charger.

To Charge Battery

- 1 Be sure the batteries are connected before charging the batteries.
- 2 Open the battery compartment. The compartment should remain open for the entire charging cycle.
- 3 Rest the cover against the chassis.
- 4 Lower the platform until the mast just contacts the battery cover.

⚠ Crushing hazard. Keep hands clear of the battery cover when lowering the platform.

- 5 Turn the key switch to the off position.
- 6 Be sure that the battery cable connections are tight and free of corrosion.

Maintenance - free batteries

- 7 Connect the battery charger to a grounded AC circuit.
- 8 The charger will indicate when the battery is fully charged.

Standard Batteries

- 7 Remove the battery vent caps and check the battery acid level. If necessary, add only enough distilled water to cover the plates. Do not overfill prior to the charge cycle.
- 8 Replace the battery vent caps.
- 9 Connect the battery charger to a grounded AC circuit.
- 10 The charger will indicate when the battery is fully charged.
- 11 Check the battery acid level when the charging cycle is complete. Replenish with distilled water to the bottom of the fill tube. Do not overfill.

Dry Battery Filling and Charging Instructions

- 1 Remove the battery vent caps and permanently remove the plastic seal from the battery vent openings.
- 2 Fill each cell with battery acid (electrolyte) until the level is sufficient to cover the plates.

Do not fill to maximum level until the battery charge cycle is complete. Overfilling can cause the battery acid to overflow during charging. Neutralize battery acid spills with baking soda and water.

- 3 Install the battery vent caps.
- 4 Charge the battery.
- 5 Check the battery acid level when the charging cycle is complete. Replenish with distilled water to the bottom of the fill tube. Do not overfill.





Observe and Obey:

- ☑ Genie Industries provides this securement information as a recommendation. Drivers are solely responsible for making sure machines are properly secured and the correct trailer is selected pursuant to US Department of Transportation regulations, other localized regulations, and their company policy.
- ☑ Genie customers needing to containerize any lift or Genie product should source a qualified freight forwarder with expertise in preparing, loading and securing construction and lifting equipment for international shipment.
- ☑ Only qualified aerial lift operators should move the machine on or off the truck.
- ☑ The transport vehicle must be parked on a level surface.
- ☑ The transport vehicle must be secured to prevent rolling while the machine is being loaded.
- ☑ Be sure the vehicle capacity, loading surfaces and chains or straps are sufficient to withstand the machine weight. Genie lifts are very heavy relative to their size. See the serial label for the machine weight.
- ☑ The machine must be on a level surface or secured before releasing the brakes.

Transport and Lifting Instructions

- ☑ Do not drive the machine on a slope that exceeds the uphill, downhill or side slope rating. See Driving on a Slope in the Operating Instructions section.
- ☑ If the slope of the transport vehicle exceeds the maximum slope rating, the machine must be loaded and unloaded using a winch as described in the brake release operation.

Brake Release Operation

- 1 Chock the wheels to prevent the machine from rolling. 
- 2 Be sure the winch line is properly secured to the drive chassis tie points and the path is clear of all obstructions.
- 3 Push in the black brake release knob to open the brake valve. 
- 4 Pump the red brake release pump knob.

After the machine is loaded:

- 1 Chock the wheels to prevent the machine from rolling.
- 2 Pull out the red Emergency Stop buttons on both the ground and platform controls to the on position.
- 3 Press the drive function select button. Press and hold the function enable switch on the control handle. Move the control handle off center and immediately release it to reset the brakes.
- 4 Push the red Emergency stop buttons on both the ground and platform controls to the off position.

Towing the GRC-12 is not recommended. If the machine must be towed, do not exceed 3.2 km/h.

Transport and Lifting Instructions

⚠ Securing to Truck or Trailer for Transit

Always chock the machine wheels in preparation for transport.

Always use the extension deck lock when the machine is transported.

Turn the key switch to the off position and remove the key before transporting.

Inspect the entire machine for loose or unsecured items.

Use the tie-down points on the chassis for anchoring down to the transport surface.

Use chains or straps of ample load capacity.

Use a minimum of 3 chains or straps.

Adjust the rigging to prevent damage to the chains.

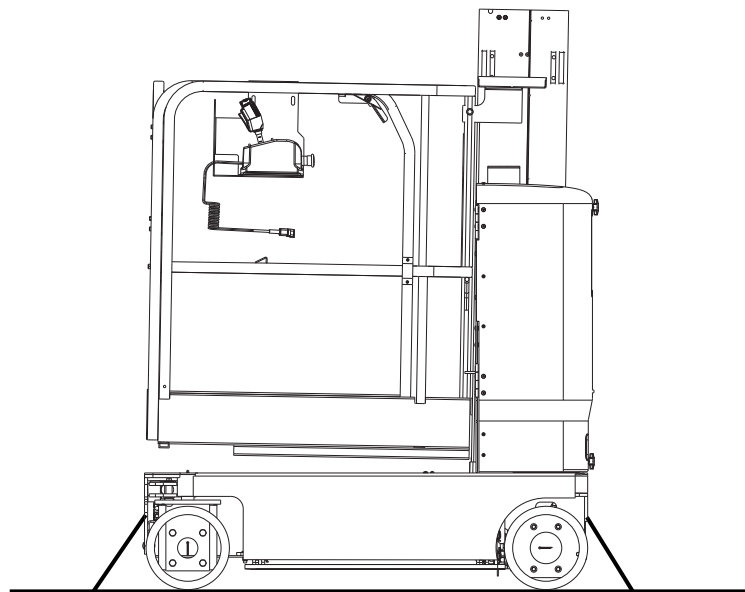
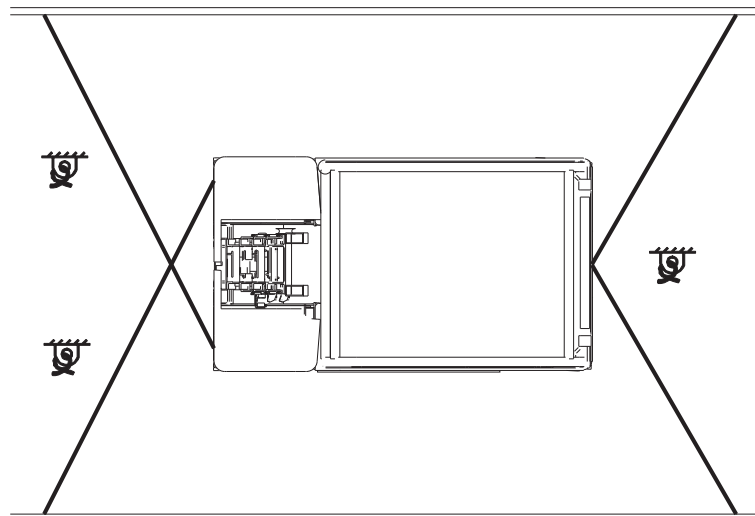



Observe and Obey:

- ☑ Only qualified riggers should rig and lift the machine.
- ☑ Be sure the crane capacity, loading surfaces and straps or lines are sufficient to withstand the machine weight. See the serial label for the machine weight.

⚠ Loading the Machine With a Crane

Use the lifting eye mounted on the rear mast column.

Make sure the mast is fully lowered.

Inspect the machine and remove any loose or unsecured items.

Always place the lifting hook through the lifting eye so that it points away from the machine.



Transport and Lifting Instructions

Lifting the Machine with a Forklift

Be sure the extension deck, controls and component trays are secure. Remove all loose items on the machine.

Fully lower the platform. The platform must remain lowered during all loading and transport procedures.

Use the forklift pockets located on both sides of the chassis, below the covers.

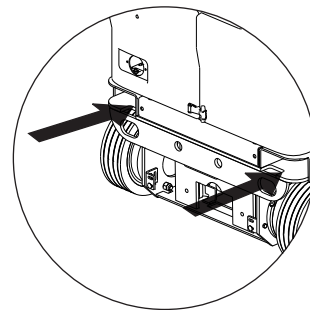

Position the forklift forks in position with the forklift pockets.

Drive forward to the full extent of the forks.

Raise the machine 15 cm and then tilt the forks back slightly to keep the machine secure.

Be sure the machine is level when lowering the forks.

NOTICE Lifting the machine from the side can result in component damage.

Maintenance



Observe and Obey:

- ☑ Only routine maintenance items specified in this manual shall be performed by the operator.
- ☑ Scheduled maintenance inspections shall be completed by qualified service technicians, according to the manufacturer's specifications and the requirements specified in the responsibilities manual.
- ☑ Use only Genie approved replacement parts.

Maintenance Symbols Legend

The following symbols have been used in this manual to help communicate the intent of the instructions. When one or more of the symbols appears at the beginning of a maintenance procedure, it conveys the meaning below.



Indicates that tools will be required to perform this procedure.



Indicates that new parts will be required to perform this procedure.

Check the Hydraulic Oil Level



Maintaining the hydraulic oil at the proper levels is essential to machine operation. Improper hydraulic oil levels can damage hydraulic components. Daily checks allow the inspector to identify changes in oil level that might indicate the presence of hydraulic system problems.

Note: Perform this procedure with the platform in the stowed position.

- 1 Visually inspect the oil level in the hydraulic tank.
- ⊙ Result: The hydraulic oil level should be as marked on the tank.
- 2 Add oil if necessary. Do not overfill.

Hydraulic oil specifications

Hydraulic oil type	Chevron Rykon Premium MV equivalent
--------------------	--

Maintenance

Check the Batteries



Proper battery condition is essential to good machine performance and operational safety. Improper fluid levels or damaged cables and connections can result in component damage and hazardous conditions.

Note: This procedure does not need to be performed on machines with sealed or maintenance - free batteries.

⚠ Electrocutation hazard. Contact with hot or live circuits may result in death or serious injury. Remove all rings, watches and other jewelry.

⚠ Bodily injury hazard. Batteries contain acid. Avoid spilling or contacting battery acid. Neutralize battery acid spills with baking soda and water.

Note: Perform this test after fully charging the batteries.

- 1 Put on protective clothing and eye wear.
- 2 Be sure that the battery cable connections are tight and free of corrosion.
- 3 Be sure that the battery hold-down bars are in place and secure.

Note: Adding terminal protectors and a corrosion preventative sealant will help eliminate the corrosion on the battery terminals and cables.

Scheduled Maintenance

Maintenance performed quarterly, annually and every two years must be completed by a person trained and qualified to perform maintenance on this machine according to the procedures found in the service manual for this machine.

Machines that have been out of service for more than three months must receive the quarterly inspection before they are put back into service.

Specifications

GRC-12	
Height, working maximum	5.5 m
Height, platform maximum	3.7 m
Height, stowed maximum	169.5 cm
Height, stowed maximum standard platform with work station tray	169.5 cm
Width	80 cm
Length, stowed	137.2 cm
Standard platform with extension extended	140 x 74.9 cm
Standard platform with extension retracted	99 x 74.9 cm
Maximum capacity, standard platform	227 kg
Maximum capacity, extension deck	113 kg
Maximum wind speed	0 m/s
Turning radius (inside)	0 cm
Turning radius (outside)	134.6 cm
Ground clearance	6.4 cm
Weight (Machine weights vary with option configurations. See serial label for specific machine weight.)	948 kg
Power source	4 Batteries, 6V 225AH
Controls	Proportional
AC outlet in platform	Standard

Maximum hydraulic pressure (functions)	207 bar
Tire size	25.4 x 7.6 x 2.5 cm
Airborne noise emissions Maximum sound level at normal operating workstations (A-weighted)	<70 dB
Vibration value does not exceed	2.5 m/s ²
Maximum slope rating, stowed position	30% (17°)
Maximum side slope rating	30% (17°)
Note: Slope rating is subject to ground conditions and adequate traction.	
Drive speeds	
Stowed, maximum	4.0 km/h 12.2 m/10.9 sec
Platform raised, maximum	0.8 km/h 12.2 m/55 sec
Floor loading information	
Tire load, maximum	381 kg
Tire contact pressure	9.09 kg/cm ² 891.01 kPa
Occupied floor pressure	880.15 kg/m ² 8.63 kPa

Note: Floor loading information is approximate and does not incorporate different option configurations. It should be used only with adequate safety factors.

Continuous improvement of our products is a Genie policy. Product specifications are subject to change without notice or obligation.

Genie Scandinavia

Phone +46 31 575100
Fax +46 31 579020

Genie France

Phone +33 (0)2 37 26 09 99
Fax +33 (0)2 37 26 09 98

Genie Iberica

Phone +34 93 579 5042
Fax +34 93 579 5059

Genie Germany

Phone +49 (0)4202 88520
Fax +49 (0)4202 8852-20

Genie U.K.

Phone +44 (0)1476 584333
Fax +44 (0)1476 584334

Genie Mexico City

Phone +52 55 5666 5242
Fax +52 55 5666 3241

Genie North America

Phone 425.881.1800
Toll Free USA and Canada
800.536.1800
Fax 425.883.3475

Genie Australia Pty Ltd.

Phone +61 7 3375 1660
Fax +61 7 3375 1002

Genie China

Phone +86 21 53852570
Fax +86 21 53852569

Genie Malaysia

Phone +65 98 480 775
Fax +65 67 533 544

Genie Japan

Phone +81 3 3453 6082
Fax +81 3 3453 6083

Genie Korea

Phone +82 25 587 267
Fax +82 25 583 910

Genie Brasil

Phone +55 11 41 665 755
Fax +55 11 41 665 754

Genie Holland

Phone +31 183 581 102
Fax +31 183 581 566

Distributed By: