



Operator's Manual

GR-26J

ANSI/CSA
North America
South America
Asia

with
Maintenance
Information

Second Edition
First Printing
Part No. 237384

Table of Contents

	Page
Introduction	1
Safety	4
Symbol and Hazard Pictorials Definitions	5
Personal Safety	7
Work Area Safety	8
Legend	15
Controls	16
Inspections	20
Operating Instructions	34
Transport and Lifting Instructions	42
Maintenance	45
Specifications	47

Copyright © 2010 by Terex Corporation

Second Edition: First Printing, June 2012

"Genie" is a registered trademarks of Terex South Dakota in the USA and many other countries.

These machines comply with
ANSI/SIA 92.5
CAN B.354.4

 Printed on recycled paper

Printed in U.S.A.

Introduction

About this Manual

Genie appreciates your choice of our machine for your application. Our number one priority is user safety, which is best achieved by our joint efforts. This book is an operation and daily maintenance manual for the user or operator of a Genie machine.

This manual should be considered a permanent part of your machine and should remain with the machine at all times. If you have any questions, call Genie.

Product Identification

The machine serial number is located on the serial label.

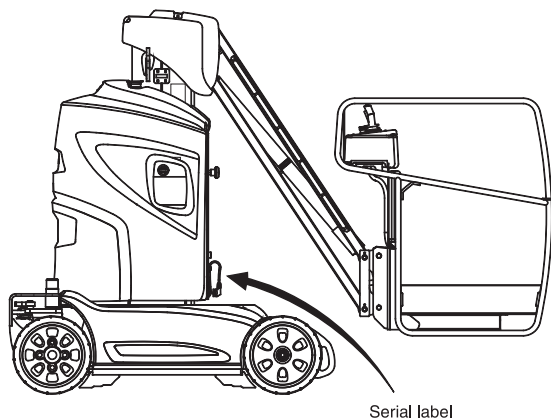

Intended Use

This machine is intended to be used only to lift personnel, along with their tools and materials to an aerial work site.

Bulletin Distribution and Compliance

Safety of product users is of paramount importance to Genie. Various bulletins are used by Genie to communicate important safety and product information to dealers and machine owners.

The information contained in the bulletins is tied to specific machines using the machine model number and PIN/serial number.

Distribution of bulletins is based on the most current owner on record along with their associated dealer, so it is important to register your machine and keep your contact information up to date.

To ensure safety of personnel and the reliable continued operation of your machine, be sure to comply with the action indicated in a respective bulletin.

Introduction

Contacting the Manufacturer

At times it may be necessary to contact Genie. When you do, be ready to supply the model number and serial number of your machine, along with your name and contact information. At minimum, Genie should be contacted for:

Accident reporting

Questions regarding product applications and safety

Standards and regulatory compliance information

Questions regarding product modifications

Current owner updates, such as changes in machine ownership or changes in your contact information. (See Transfer of Ownership, below.)

Internet: <http://www.genielift.com>

e-mail: awp.techpub@terex.com

Transfer of Machine Ownership

Taking a few minutes to update owner information will ensure that you receive important safety, maintenance and operating information that applies to your machine.

Please register your machine by visiting us on the web at www.genielift.com or by calling us toll free at 1-800-536-1800.

Introduction



Warning

Failure to obey the instructions and safety rules in this manual could result in death or serious injury.

Do Not Operate Unless:

- You learn and practice the principles of safe machine operation contained in this operator's manual.

1 Avoid hazardous situations.

Know and understand the safety rules before going on to the next section.

- 2 Always perform a pre-operation inspection.
 - 3 Always perform function tests prior to use.
 - 4 Inspect the workplace.
 - 5 Only use the machine as it was intended.
- You read, understand and obey the manufacturer's instructions and safety rules—safety and operator's manuals and machine decals.
 - You read, understand and obey employer's safety rules and worksite regulations.
 - You read, understand and obey all applicable governmental regulations.
 - You are properly trained to safely operate the machine.

Safety

Hazard Classification

Genie uses symbols, color coding and signal words to identify the following:



Safety alert symbol—used to alert you to potential personal injury hazards. Obey all safety messages that follow this symbol to avoid possible injury or death.

▲ DANGER

Red

Indicates a hazardous situation which, if not avoided, will result in death or serious injury.

▲ WARNING

Orange

Indicates a hazardous situation which, if not avoided, could result in death or serious injury.

▲ CAUTION

Yellow

Indicates a hazardous situation which, if not avoided, could result in minor or moderate injury.

NOTICE















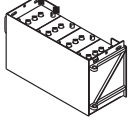



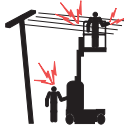

Blue

Indicates a property damage message.



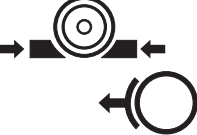







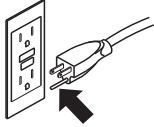

Safety Sign Maintenance

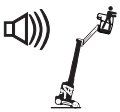
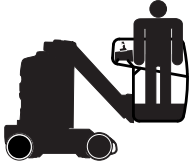
Replace any missing or damaged safety signs. Keep operator safety in mind at all times. Use mild soap and water to clean safety signs. Do not use solvent-based cleaners because they may damage the safety sign material.

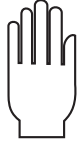
Symbol and Hazard Pictorials Definitions

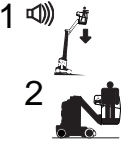
 <p>Crush Hazard</p>	 <p>Electrocution Hazard</p>	 <p>Fire Hazard</p>	 <p>Explosion Hazard</p>	 <p>Burn Hazard</p>
 <p>Fall Hazard</p>	 <p>Batteries used as counterweight</p>	 <p>No Open Flames</p>	 <p>Tip-over Hazard</p>	 <p>No Smoking</p>
 <p>Voltage rating for power to platform</p>	 <p>Electrocution Hazard</p>	 <p>Maintain required clearance</p>	 <p>Keep away from moving parts</p>	 <p>Read the operator's manual</p>
 <p>No smoking No flame. Stop engine</p>	 <p>Keep off this surface</p>	 <p>Only trained maintenance personnel should access compartments</p>	 <p>Collision Hazard</p>	 <p>Chock wheels before releasing brakes.</p>
 <p>Crush Hazard</p>	 <p>Keep away from elevated components while servicing machine</p>	 <p>Collision Hazard</p>	 <p>Do not stand under raised platform</p>	

Symbol and Hazard Pictorials Definitions

 <p>Grounded AC 3-wire outlet only</p>	 <p>Replace damaged wires and cords</p>	 <p>Lanyard attachment point</p>	 <p>Wheel load</p>	 <p>Tip-over Hazard</p>
 <p>Maximum occupants: 1</p>	 <p>Maximum Capacity</p>	 <p>Maximum Side Force</p>	 <p>Maximum Wind Speed</p>	 <p>1 2</p> <p>When tilt alarm sounds, lower platform</p>
 <p>Collision Hazard</p>	 <p>Keep away from overhead obstacles.</p>	 <p>Runaway Hazard</p>	 <p>Determine slope rating.</p>	

Personal Safety

Fall Protection

Personal fall protection equipment (PFPE) is required when operating this machine.

Occupants must wear a safety belt or harness in accordance with governmental regulations. Attach the lanyard to the anchor provided in the platform.

Operators must comply with employer, job site and governmental rules regarding the use of personal protective equipment.

All PFPE must comply with applicable governmental regulations, and must be inspected and used in accordance with the PFPE manufacturer's instructions.

Work Area Safety

⚠️ Electrocutation Hazards



This machine is not electrically insulated and will not provide protection from contact with or proximity to electrical current.



Maintain required clearances from electrical power lines and apparatus in accordance with applicable governmental regulations and the following chart.

Line Voltage	Required Clearance	
0 to 50KV	10 ft	3.0 m
50 to 200KV	15 ft	4.6 m
200 to 350KV	20 ft	6.1 m
350 to 500KV	25 ft	7.6 m
500 to 750KV	35 ft	10.6 m
750 to 1000KV	45 ft	13.7 m

Allow for platform movement, electrical line sway or sag and beware of strong or gusty winds.

Keep away from the machine if it contacts energized power lines. Personnel on the ground or in the platform must not touch or operate the machine until energized power lines are shut off.

Do not operate the machine during lightning or storms.

Do not use the machine as a ground for welding.

⚠️ Tip-over Hazards

Occupants, equipment and materials shall not exceed the maximum platform capacity.

Maximum platform capacity	500 lbs	227 kg
----------------------------------	---------	--------

If using accessories, read, understand and obey the decals and instructions with the accessory.

Do not alter or disable the limit switches.



Do not raise the platform unless the machine is on a firm, level surface.

Do not depend on the tilt alarm as a level indicator. The tilt alarm sounds in the platform only when the machine is on a severe slope.



If the tilt alarm sounds: Lower the mast, then lower the jib boom. Move the machine to a firm, level surface. Use extreme caution to lower the mast.

Work Area Safety

When raising the platform, follow ratings for allowable manual force and number of occupants below.

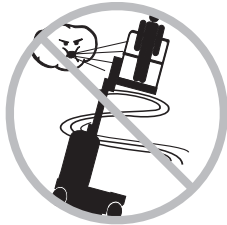

Do not operate the machine in strong or gusty winds. Do not increase the surface area of the platform or the load. Increasing the area exposed to the wind will decrease machine stability.



Use extreme care and slow speeds while driving the machine in the stowed position across uneven terrain, debris, unstable or slippery surfaces and near holes and drop-offs.

Do not drive the machine on or near uneven terrain, unstable surfaces or other hazardous conditions with the boom raised or extended.



Do not push off or pull toward any object outside of the platform.

Maximum side force	150 ft/lbs / 667 N
Maximum occupants	2

Do not alter or disable machine components that in any way affect safety and stability.

Do not replace items critical to machine stability with items of different weight or specification.

Do not modify or alter an aerial work platform without prior written permission from the manufacturer. Mounting attachments for holding tools or other materials onto the platform, toeboards or guard rail system can increase the weight in the platform and the surface area of the platform or the load.

Work Area Safety



Do not place or attach overhanging loads to any part of this machine.

Do not place ladders or scaffolds in the platform or against any part of this machine.



Do not transport tools and materials unless they are evenly distributed and can be safely handled by person(s) in the platform.



Do not use the machine on a moving or mobile surface or vehicle.

Be sure all tires are in good condition and lug nuts are properly tightened.

Do not use the platform controls to free a platform that is caught, snagged or otherwise prevented from normal motion by an adjacent structure. All personnel must be removed from the platform before attempting to free the platform using the ground controls.

Do not use batteries that weigh less than the original equipment. Batteries are used as counterweight and are critical to machine stability. The battery box, including batteries, must weigh a minimum of 467 lbs / 212 kg.

Do not use the machine as a crane.

Do not push the machine or other objects with the boom.

Do not contact adjacent structures with the boom.

Do not tie the boom or platform to adjacent structures.

Do not place loads outside the platform perimeter.

⚠ Operation on Slopes Hazards

Do not drive the machine on a slope that exceeds the maximum slope or side slope rating of the machine. Slope rating applies only to machines in the stowed position.

Maximum slope rating, stowed position	25% (14°)
--	-----------

Maximum side slope rating, stowed position	15% (9°)
---	----------

Note: Slope rating is subject to ground conditions and adequate traction. See Driving on a Slope in the Operating Instructions section.

Work Area Safety

⚠ Fall Hazards

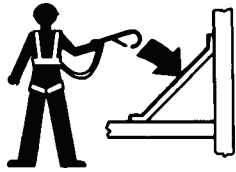

Occupants must wear a safety belt or harness in accordance with governmental regulations. Attach the lanyard to the anchor provided in the platform.



Do not sit, stand or climb on the platform guard rails. Maintain a firm footing on the platform floor at all times.

Do not climb down from the platform when raised.



Keep the platform floor clear of debris.

Lower the platform entry mid-rail or close the entry gate before operating.

Do not enter or exit the platform unless the machine is in the stowed position and the platform is at ground level.

⚠ Collision Hazards



Be aware of limited sight distance and blind spots when driving or operating.

Be aware of the platform position and tailswing when rotating the turntable.



Check the work area for overhead obstructions or other possible hazards.

Be aware of crushing hazards when grasping the platform guard rail.



Operators must comply with employer, job site and governmental rules regarding the use of personal protective equipment.

Observe and use the color-coded direction arrows on the platform controls and drive chassis for drive and steer functions.

Work Area Safety



Do not lower the boom unless the area below is clear of personnel and obstructions.

Limit travel speed according to the condition of the ground surface, congestion, slope, location of personnel, and any other factors which may cause collision.



Do not operate a boom in the path of any crane unless the controls of the crane have been locked out and/or precautions have been taken to prevent any potential collision.

No stunt driving or horseplay while operating a machine.

The machine must be on a level surface or secured before releasing the brakes.

⚠ Explosion and Fire Hazards

Charge the battery only in an open, well-ventilated area away from sparks, flames and lighted tobacco.

Do not operate the machine or charge the batteries in hazardous locations or locations where potentially flammable or explosive gases or particles may be present.

⚠ Bodily Injury Hazard

Do not operate the machine with a hydraulic oil or air leak. An air leak or hydraulic leak can penetrate and/or burn skin.

Improper contact with components under any cover will cause serious injury. Only trained maintenance personnel should access compartments. Access by the operator is only advised when performing a pre-operation inspection. All compartments must remain closed and secured during operation.

⚠ Damaged Machine Hazards

Do not use a damaged or malfunctioning machine.

Conduct a thorough pre-operation inspection of the machine and test all functions before each work shift. Immediately tag and remove from service a damaged or malfunctioning machine.

Be sure all maintenance has been performed as specified in this manual and the appropriate service manual.

Be sure all decals are in place and legible.

Be sure the operator's, safety and responsibilities manuals are complete, legible and in the storage container located on the platform.

⚠ Component Damage Hazard

Do not use the machine as a ground for welding.

Work Area Safety

⚠ Battery Safety

Burn Hazards

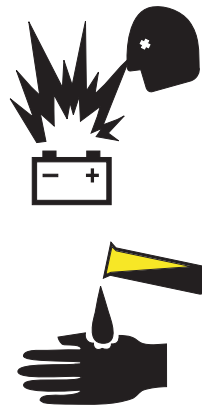

Batteries contain acid. Always wear protective clothing and eye wear when working with batteries.

Avoid spilling or contacting battery acid. Neutralize battery acid spills with baking soda and water.

The battery pack must remain in the upright position.

Do not expose the batteries or the charger to water or rain.

Explosion Hazards



Keep sparks, flames and lighted tobacco away from batteries. Batteries emit an explosive gas.

The battery pack cover must remain off during the entire charging cycle.

Do not contact the battery terminals or the cable clamps with tools that may cause sparks.

Component Damage Hazards

Do not use any battery charger greater than 48V to charge the batteries.

Electrocution Hazards



Connect the battery charger to a grounded, AC 3-wire electrical outlet only.

Inspect daily for damaged cord, cables and wires. Replace damaged items before operating.

Avoid electrical shock from contact with battery terminals. Remove all rings, watches and other jewelry.

Tip-over Hazard

Do not use batteries that weigh less than the original equipment. Batteries are used as counterweight and are critical to machine stability. The battery box, including batteries, must weigh a minimum of 467 lbs / 212 kg.

Lifting Hazard

Use a suitable lifting device to remove or install the batteries.

Work Area Safety

Lockout After Each Use

- 1 Select a safe parking location—firm level surface, clear of obstruction and traffic.
- 2 Lower the jib boom and the mast to the stowed position.
- 3 Rotate the turntable so that the platform is between the non-steer wheels.
- 4 Turn the key switch to the off position and remove the key to secure from unauthorized use.
- 5 Chock the wheels.

Legend

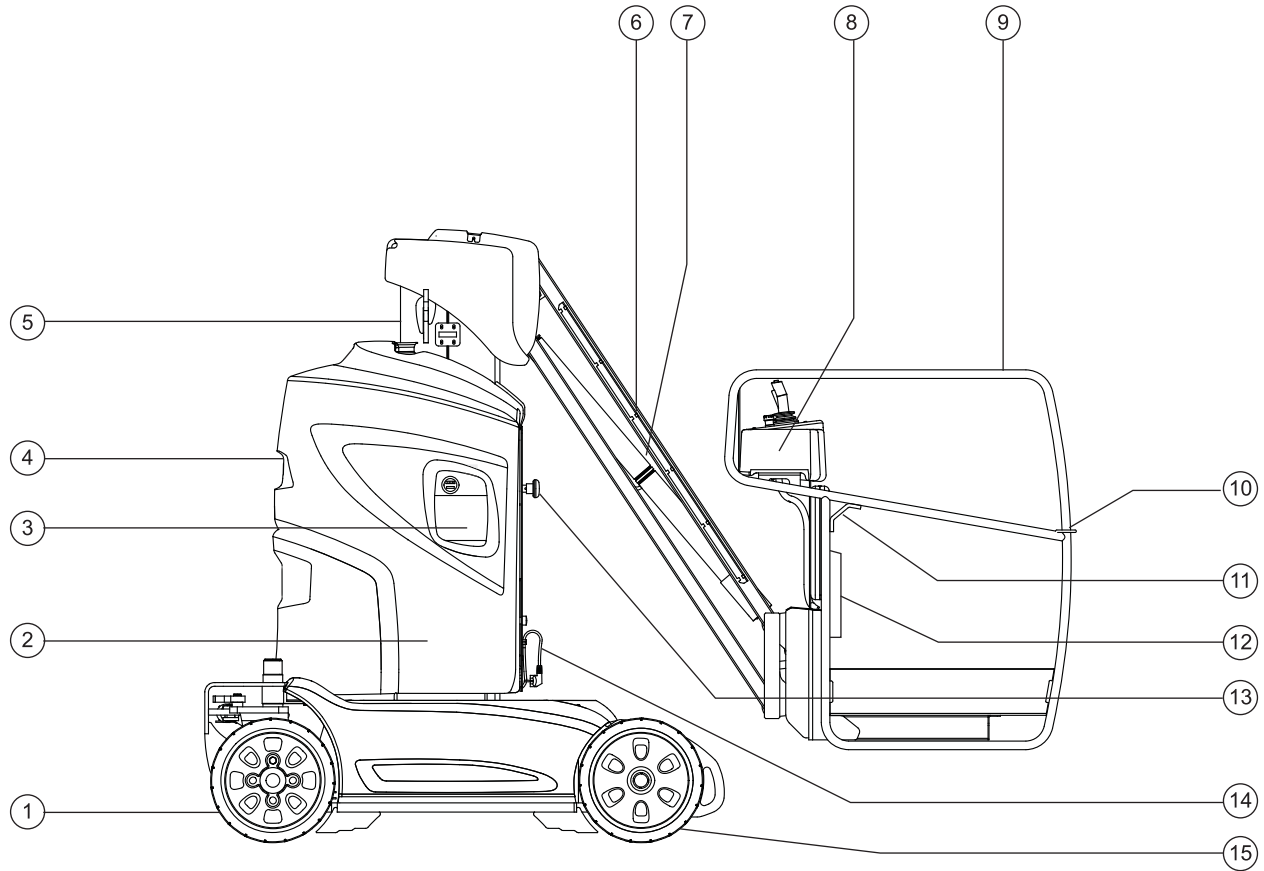

- | | |
|---|------------------------------|
| 1 Steer tire | 9 Platform |
| 2 Emergency lowering controls (also under cover on opposite side) | 10 Sliding mid-rail |
| 3 Ground controls | 11 Lanyard anchorage point |
| 4 Batteries (under cover) | 12 Manual storage container |
| 5 Mast | 13 Red Emergency Stop button |
| 6 Jib boom | 14 Power to charger |
| 7 Emergency lowering valve for jib boom | 15 Non-steer tire |
| 8 Platform controls | |

Controls

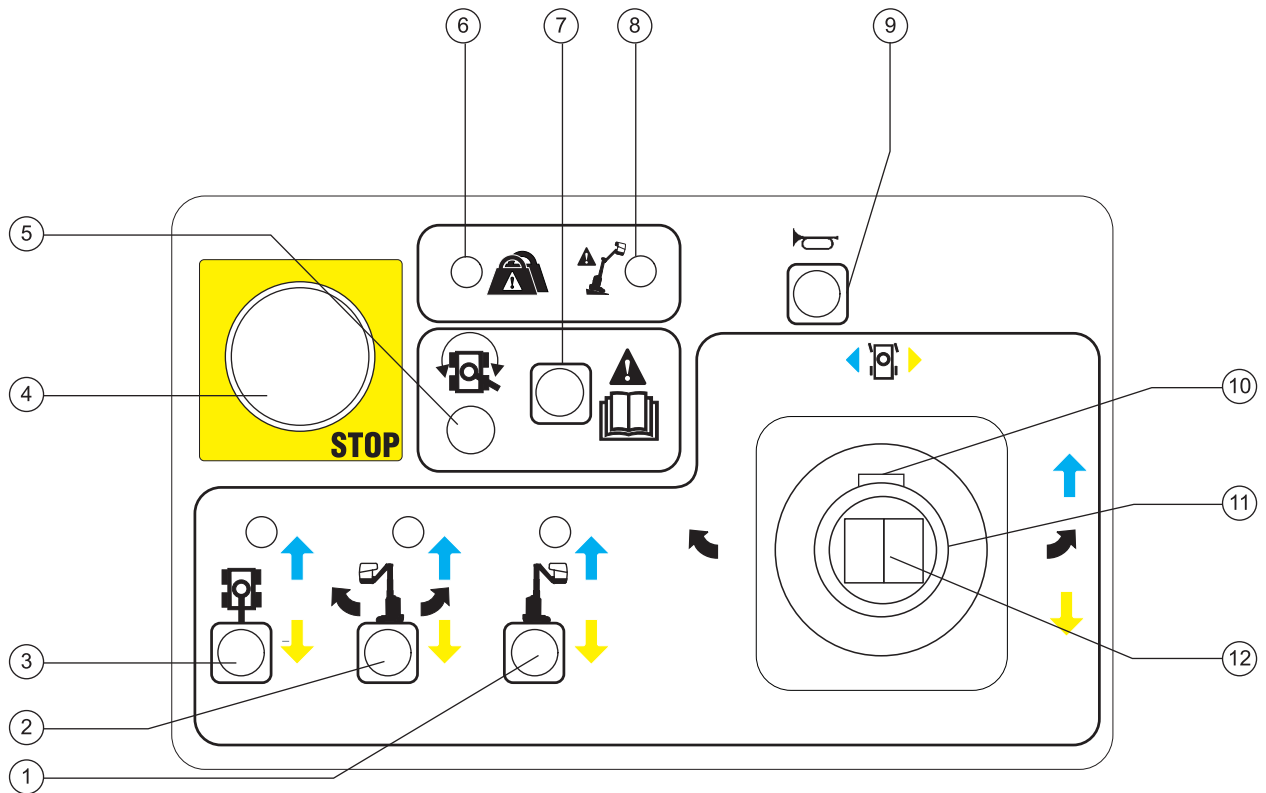

Platform Control Panel

- | | |
|---|---|
| 1 Jib boom function button with indicator light | 8 Machine not level indicator light |
| 2 Mast function and turntable rotate function button with indicator light | 9 Horn button |
| 3 Drive function button with indicator light | 10 Function enable switch for drive and boom functions |
| 4 Red Emergency Stop button | 11 Proportional control handle for drive and boom functions |
| 5 Drive enable indicator light | 12 Thumb rocker switch for steer functions |
| 6 Not used | |
| 7 Drive enable button | |

Controls

Platform Control Panel

- 1 Jib boom function button with indicator light
Push the jib boom function button to select the jib boom function. The indicator light will be on.
- 2 Mast function and turntable rotate function button with indicator light
Push the mast function and turntable rotate function button to select the mast and turntable rotate functions. The indicator light will be on.
- 3 Drive function button with indicator light
Push the drive function button to select the drive and steer function. The indicator light will be on.
- 4 Red Emergency Stop button
Push in the red Emergency Stop button to the off position to stop all functions. Twist the red Emergency Stop button to the on position to operate the machine.
- 5 Drive enable indicator light
Light on indicates that the boom has moved just past either non-steer wheel and drive function has been interrupted.
- 6 Not used
- 7 Drive enable button
To drive when the drive enable light is on, push and hold the drive enable button, push the drive function button and slowly move the drive control handle off center. Be aware that the machine may move in the opposite direction that the drive and steer controls are moved.
- 8 Machine not level indicator light
The machine not level indicator light will come on when the tilt alarm sounds.
- 9 Horn button
Push the horn button and the horn will sound. Release the horn button and the horn will stop.
- 10 Function enable switch for drive and boom functions
Press and hold the function enable switch on the control handle to enable the functions.
- 11 Proportional control handle for drive and boom functions
Move the control handle in the direction indicated by the blue arrow and the machine functions will operate in the direction indicated by the blue arrow. Move the control handle in the direction indicated by the yellow arrow and the machine functions will operate in the direction indicated by the yellow arrow. Move the control handle to the left and the turntable will rotate to the left. Move the control handle to the right and the turntable will rotate to the right.
- 12 Thumb rocker switch for steer functions
Press the left side of the thumb rocker and the machine will steer to the left. Press the right side of the thumb rocker and the machine will steer to the right.

Controls

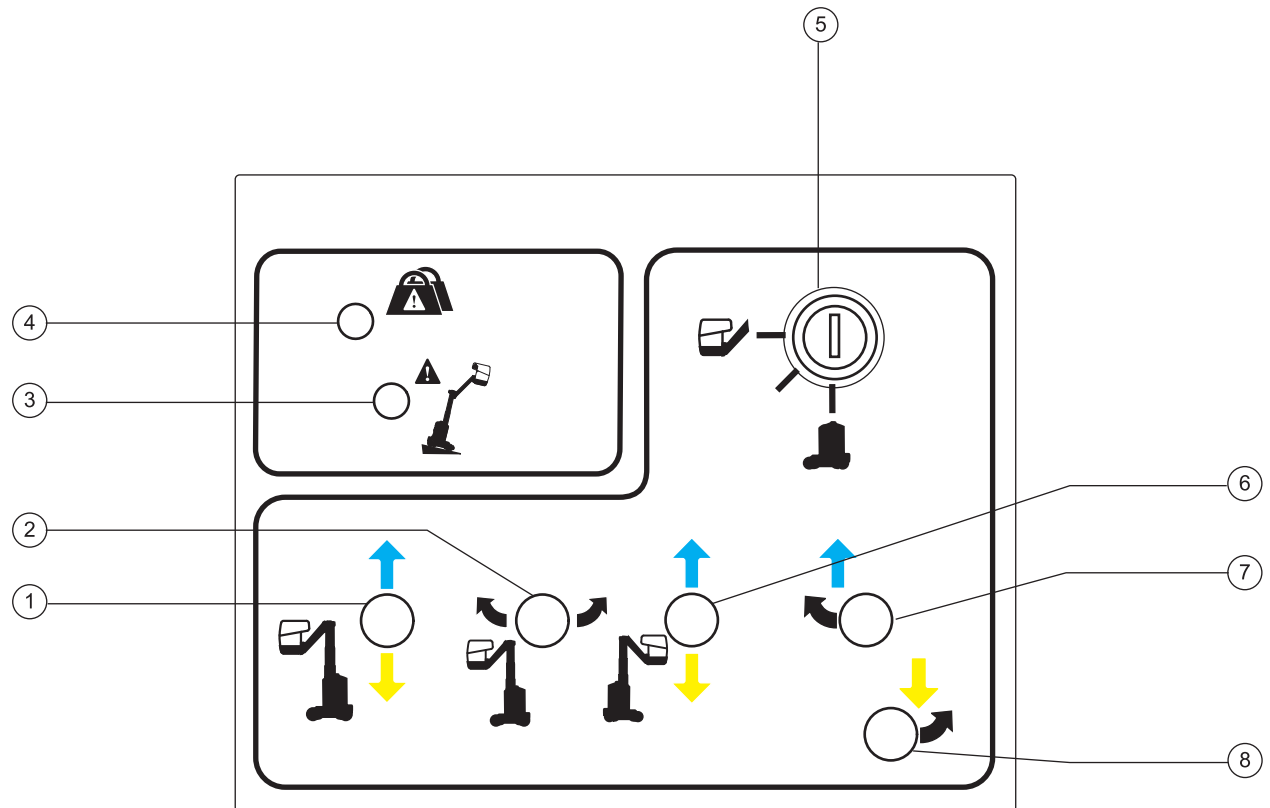

Ground Control Panel

- | | |
|--|--|
| <ul style="list-style-type: none"> 1 Mast up/down button 2 Turntable rotate left/right button 3 Machine not level indicator light 4 Not used | <ul style="list-style-type: none"> 5 Key switch for platform/off/ground operation 6 Jib boom up/down button 7 Function enable button for mast up, jib boom up and turntable rotate left functions 8 Function enable button for mast down, jib boom down and turntable rotate right functions |
|--|--|

Controls

Ground Control Panel

1 Mast up/down button

Push and hold the mast up/down button to select the mast up/down function.

2 Turntable rotate left/right button

Push and hold the turntable rotate left/right button to select the turntable rotate left/right function.

3 Machine not level indicator light

The machine not level indicator light will come on when the tilt alarm sounds.

4 Not used

5 Key switch for platform/off/ground operation

Turn the key switch to the platform position and the platform controls will operate. Turn the key switch to the center position and the machine will be off. Turn the key switch to the ground position and the ground controls will operate.

6 Jib boom up/down button

Push and hold the jib boom up/down button to select the jib boom up/down function.

7 Function enable button for mast up, jib boom up and turntable rotate left functions

Press and hold this function enable button to enable the mast up, jib boom up and turntable rotate left functions

8 Function enable button for mast down, jib boom down and turntable rotate right functions

Press and hold this function enable button to enable the mast down, jib boom down and turntable rotate right functions

Inspections



Do Not Operate Unless:

- You learn and practice the principles of safe machine operation contained in this operator's manual.
 - 1 Avoid hazardous situations.
 - 2 Always perform a pre-operation inspection.**
- Know and understand the pre-operation inspection before going on to the next section.**
- 3 Always perform function tests prior to use.
- 4 Inspect the workplace.
- 5 Only use the machine as it was intended.

Pre-operation Inspection Fundamentals

It is the responsibility of the operator to perform a pre-operation inspection and routine maintenance.

The pre-operation inspection is a visual inspection performed by the operator prior to each work shift. The inspection is designed to discover if anything is apparently wrong with a machine before the operator performs the function tests.

The pre-operation inspection also serves to determine if routine maintenance procedures are required. Only routine maintenance items specified in this manual may be performed by the operator.

Refer to the list on the next page and check each of the items.

If damage or any unauthorized variation from factory delivered condition is discovered, the machine must be tagged and removed from service.

Repairs to the machine may only be made by a qualified service technician, according to the manufacturer's specifications. After repairs are completed, the operator must perform a pre-operation inspection again before going on to the function tests.

Scheduled maintenance inspections shall be performed by qualified service technicians, according to the manufacturer's specifications and the requirements listed in the responsibilities manual.

Inspections

Pre-operation Inspection

- Be sure that the operator's, safety and responsibilities manuals are complete, legible and in the storage container located in the platform.
- Be sure that all decals are legible and in place. See Inspections section.
- Check for hydraulic oil leaks and proper oil level. Add oil if needed. See Maintenance section.
- Check for battery fluid leaks and proper fluid level. Add distilled water if needed. See Maintenance section.

Check the following components or areas for damage, improperly installed or missing parts and unauthorized modifications:

- Electrical components, wiring and electrical cables
- Hydraulic hoses, fittings, cylinders and manifolds
- Hydraulic tank
- Drive and turntable motors and drive hubs
- Mast wear pads
- Tires and wheels
- Limit switches and horn
- Alarms and beacons (if equipped)
- Nuts, bolts and other fasteners
- Platform entry mid-rail

Check entire machine for:

- Cracks in welds or structural components
- Dents or damage to machine
- Excessive rust, corrosion or oxidation
- Be sure that all structural and other critical components are present and all associated fasteners and pins are in place and properly tightened.
- Be sure that the batteries are in place and properly connected.
- After you complete your inspection, be sure that all compartment covers are in place and latched.

Inspections



Do Not Operate Unless:

- You learn and practice the principles of safe machine operation contained in this operator's manual.
 - 1 Avoid hazardous situations.
 - 2 Always perform a pre-operation inspection.
 - 3 Always perform function tests prior to use.**
- Know and understand the function tests before going on to the next section.**
 - 4 Inspect the workplace.
 - 5 Only use the machine as it was intended.

Function Test Fundamentals

The function tests are designed to discover any malfunctions before the machine is put into service. The operator must follow the step-by-step instructions to test all machine functions.

A malfunctioning machine must never be used. If malfunctions are discovered, the machine must be tagged and removed from service. Repairs to the machine may only be made by a qualified service technician, according to the manufacturer's specifications.

After repairs are completed, the operator must perform a pre-operation inspection and function tests again before putting the machine into service.

Inspections

- 1 Select a test area that is firm, level and free of obstruction.

At the Ground Controls

- 2 Turn the key switch to ground control.
- 3 Pull out the red Emergency Stop button to the on position.

Test Emergency Stop

- 4 Push in the red Emergency Stop button to the off position.
- 5 Activate each machine function.
- ⦿ Result: No functions should operate.
- 6 Pull out the red Emergency Stop button to the on position.

Test Machine Functions and Descent Alarm

- 7 Do not press and hold any of the function enable buttons. Attempt to activate each function.
- ⦿ Result: All functions should not operate.
- 8 Press and hold the function enable button for mast up, jib boom up and turntable rotate left. Push and hold the button for the mast up function, the jib boom up function and the turntable rotate left function.
- ⦿ Result: The functions should operate through a full cycle. The descent alarm should sound while the mast is lowering.

- 9 Press and hold the function enable button for mast down, jib boom down and turntable rotate right. Press and hold the button for the mast down function, the jib boom down function and the turntable rotate right function.

- ⦿ Result: The functions should operate through a full cycle. The descent alarm should sound while the boom is lowering.

Test the Tilt Sensor

- 10 Pull out the platform red Emergency Stop button to the on position. Turn the key switch to platform control.
- 11 Raise the platform 10 cm.
- 12 Open the turntable cover on the ground controls side and locate the tilt sensor.
- 13 Press down on the top of the tilt sensor.
- ⦿ Result: The alarm should sound.
- 14 Lower the platform.

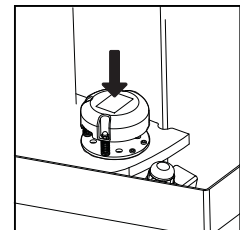

Inspections

At the Platform Controls

- 15 Turn the key switch to platform control.
- 16 Twist the red Emergency Stop button to the on position.

Test Emergency Stop

- 17 Push in the platform red Emergency Stop button to the off position.
- 18 Activate each machine function.
 - ⦿ Result: No functions should operate.
- 19 Twist the red Emergency Stop button to the on position.

Test the Horn

- 20 Push the horn button.
 - ⦿ Result: The horn should sound.

Test the Function Enable Switch

- 21 Do not hold the function enable switch on the control handle.
- 22 Slowly move the control handle in the direction indicated by the blue arrow, then in the direction indicated by the yellow arrow.
 - ⦿ Result: No functions should operate.

Test Machine Functions and Descent Alarm

- 23 Push the jib boom function button.
 - ⦿ Result: The indicator light above the function button should be on.
- 24 Press and hold the function enable switch on the control handle.
- 25 Move the control handle in the direction indicated by the blue arrow.
 - ⦿ Result: The jib should raise.
- 26 Press and hold the function enable switch on the control handle.
- 27 Move the control handle in the direction indicated by the yellow arrow.
 - ⦿ Result: The jib should lower and the descent alarm will sound.
- 28 Push the mast function and turntable rotate function button.
 - ⦿ Result: The indicator light above the function button should be on.
- 29 Press and hold the function enable switch on the control handle.
- 30 Move the control handle in the direction indicated by the blue arrow.
 - ⦿ Result: The mast should raise.
- 31 Press and hold the function enable switch on the control handle.

Inspections

32 Move the control handle in the direction indicated by the yellow arrow.

- ⦿ Result: The mast should lower. The descent alarm should sound when the mast is lowering.

33 Press and hold the function enable switch on the control handle.

34 Move the control handle to the left.

- ⦿ Result: The turntable should rotate to the left.

35 Press and hold the function enable switch on the control handle.

36 Move the control handle to the right.

- ⦿ Result: The turntable should rotate to the right.

Test the Steering

37 Press the drive function button.

- ⦿ Result: The indicator light above the function button should be on.

38 Press and hold the function enable switch on the control handle.

39 Press the thumb rocker switch on top of the drive control handle in the direction indicated by the blue triangle on the control panel.

- ⦿ Result: The steer wheels should turn in the direction that the blue triangles point on the drive chassis.

40 Press the thumb rocker switch in the direction indicated by the yellow triangle on the control panel.

- ⦿ Result: The steer wheels should turn in the direction that the yellow triangles point on the drive chassis.

Test Drive and Braking

41 Press the drive function button.

- ⦿ Result: The indicator light above the function button should be on.

42 Press and hold the function enable switch on the control handle.

43 Slowly move the drive control handle in the direction indicated by the blue arrow on the control panel until the machine begins to move, then return the handle to the center position.

- ⦿ Result: The machine should move in the direction that the blue arrow points on the drive chassis, then come to an abrupt stop.

44 Slowly move the drive control handle in the direction indicated by the yellow arrow on the control panel until the machine begins to move, then return the handle to the center position.

- ⦿ Result: The machine should move in the direction that the yellow arrow points on the drive chassis, then come to an abrupt stop.

Note: The brakes must be able to hold the machine on any slope it is able to climb.

Inspections

Test the Drive Enable System

- 45 Push the mast function and turntable rotate function button.
- 46 Press and hold the function enable switch on the control handle.
- 47 Rotate the turntable until the jib boom moves past one of the non-steer wheels.

- ⦿ Result: The drive enable indicator light should come on and remain on while the jib boom is anywhere in the range shown.



- 48 Push the drive function button.
- 49 Press and hold the function enable switch on the control handle.
- 50 Move the drive control handle off center.
- ⦿ Result: The drive function should not operate.
- 51 Push and hold the drive enable button and then push the drive function button.
- ⦿ Result: The drive function indicator light should come on.
- 52 Slowly move the drive control handle off center.
- ⦿ Result: The drive function should operate.

Note: When the drive enable system is in use, the machine may drive in the opposite direction that the drive and steer control handle is moved.

Use the color-coded direction arrows on the platform controls and the drive chassis to identify the direction of travel.

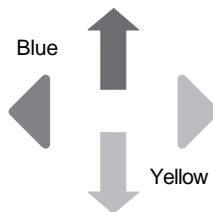

Test Limited Drive Speed

- 53 Push the mast function and turntable rotate function button.
- 54 Press and hold the function enable switch on the control handle.
- 55 Raise the mast approximately 4 in / 10 cm.
- 56 Push the drive function button.
- 57 Press and hold the function enable switch on the control handle.
- 58 Move the drive control handle off center.
- ⦿ Result: The maximum achievable drive speed with the mast raised should not exceed 1.5 ft / 18 cm per second.
- 59 Lower the mast. Raise the jib boom until the platform floor is approximately 1 m from the ground.
- 60 Slowly move the drive control handle to the full drive position.
- ⦿ Result: The maximum achievable drive speed with the jib boom raised should not exceed 1.5 ft / 18 cm per second.
- 61 Lower the jib boom to the stowed position.

If the drive speed with the mast raised or the jib boom raised exceeds 1.5 ft / 18 cm per second, immediately tag and remove the machine from service.

Inspections

Test Emergency Functions

To Lower the Mast

62 Open the turntable cover opposite the ground controls.

63 Locate the mast function valve on the function manifold.

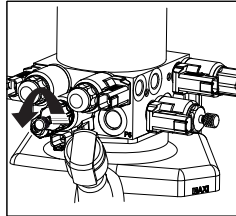

64 Turn the cap counterclockwise to open the valve.

65 Open the turntable cover on the ground controls side.

66 Locate the emergency lowering button.

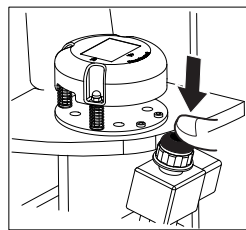

67 Push and hold the emergency lowering button.

⦿ Result: The mast should lower.

68 Turn the cap on the valve clockwise to close the mast function valve.

To Rotate the Turntable

69 Open the turntable cover opposite the ground controls.

70 Locate the valve on the function manifold, used for manually operating functions.

71 Turn the cap counterclockwise for turntable rotate right. Turn the cap clockwise for turntable rotate left.

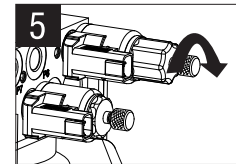

72 Insert the manual hand pump handle into the pump.

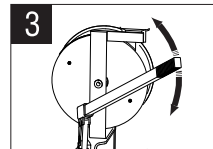

73 Locate the turntable rotate valve on the function manifold. Push and hold the black button on the end of the valve.

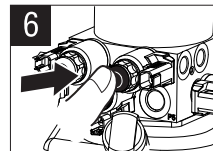

74 While holding the black button, pump the handle up and down.

⦿ Result: The turntable will rotate.

75 Turn the valve on the function manifold all the way in the counterclockwise direction to reset the valve.

76 The manual hand pump handle is stored under the chassis covers in front of the batteries.

Inspections

To Lower the Jib Boom

77 Lower the mast using the Emergency Lowering procedure To Lower the Mast.

78 Locate the valve on the jib boom.

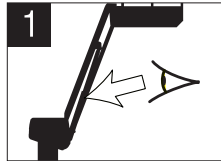

79 Turn the cap on the jib boom valve counterclockwise to open the valve.

80 Open the turntable cover opposite the ground controls.

81 Locate the valve on the function manifold used for manually operating functions.

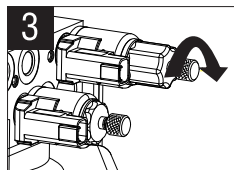

82 Slowly turn the cap on the valve clockwise.

⊙ Result: The jib boom will lower when the valve is turned to the center of the range of motion.

83 When the jib boom is lowered, turn the cap on the jib boom valve clockwise to close the valve.

84 At the function manifold, turn the cap on the manual function valve counterclockwise, to close the valve.

To Steer

85 Open the turntable cover opposite the ground controls.

86 Locate the steer valve on the function manifold. Push and hold the black button on the end of the valve.

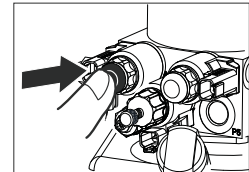

87 Insert the manual hand pump handle into the pump and pump the handle up and down.

⊙ Result: The tires steer to the right.

88 Locate the valve on the function manifold used for manually operating functions.

89 Turn the cap on the valve counterclockwise.

90 Locate the steer valve on the function manifold. Push and hold the black button on the end of the valve.

91 Insert the manual hand pump handle into the pump and pump the handle up and down.

⊙ Result: The tires steer to the left.

92 The manual hand pump handle is stored under the chassis covers in front of the batteries.

Inspections



Do Not Operate Unless:

- You learn and practice the principles of safe machine operation contained in this operator's manual.

- 1 Avoid hazardous situations.
- 2 Always perform a pre-operation inspection.
- 3 Always perform function tests prior to use.

4 Inspect the workplace.

Know and understand the workplace inspection before going on to the next section.

- 5 Only use the machine as it was intended.

Fundamentals

The workplace inspection helps the operator determine if the workplace is suitable for safe machine operation. It should be performed by the operator prior to moving the machine to the workplace.

It is the operator's responsibility to read and remember the workplace hazards, then watch for and avoid them while moving, setting up and operating the machine.

Workplace Inspection

Be aware of and avoid the following hazardous situations:

- drop-offs or holes
- bumps, floor obstructions or debris
- sloped surfaces
- unstable or slippery surfaces
- overhead obstructions and high voltage conductors
- hazardous locations
- inadequate surface support to withstand all load forces imposed by the machine
- wind and weather conditions
- the presence of unauthorized personnel
- other possible unsafe conditions

Inspections

Inspection for Decals with Words

Determine whether the decals on your machine have words or symbols. Use the appropriate inspection to verify that all decals are legible and in place.

Part No.	Description	Quantity
28161	Warning - Crush Hazard	2
28175	Warning - Compartment Access	1
28236	Warning - Read the Manual	2
37053	Label - Blue Arrow	1
37054	Label - Yellow Arrow	1
37055	Label - Blue Triangle	2
37056	Label - Yellow Triangle	2
40434	Label - Lanyard Anchorage	2
44980	Label - Power to Charger, 115V	1
52475	Label - Transport Tie-down	4
72086	Label - Lifting Eye	2
97815	Label - Lower Mid-rail	1
133092	Danger - Crushing Hazard	2
215812	Danger - Tip-over Hazard	1
215813	Instructions - Operating Instructions	1
216032	Label - Power to Platform, 115V	2
231440	Warning - No Step or Ride	1
231441	Danger - Tip-over Hazard, Batteries	1
231442	Warning - Collision Hazard	1
231443	Danger - Tip-over Hazard	1

Part No.	Description	Quantity
231444	Warning - Slope Hazard	1
231446	Warning - Drive Enable Hazard	1
231448	Danger - Tip-over Hazard	1
231449	Label - Tire Specifications	4
231625	Warning/Instructions - Brake Release	1
237380	Warning - Electrocution Hazard	1
237381	Danger - Electrocution Hazard	3
237382	Warning - Collision Hazard	1
237383	Danger - Electrocution/Burn Hazard	1
T108701	Platform Control Panel	1
T108702	Ground Control Panel	1
T110010	Cosmetic - Genie Logo	1
T110011	Cosmetic - Genie GR-26J	2
T110014	Label - Wheel Load	4
T110017	Label - Emergency Lowering	1

Inspections

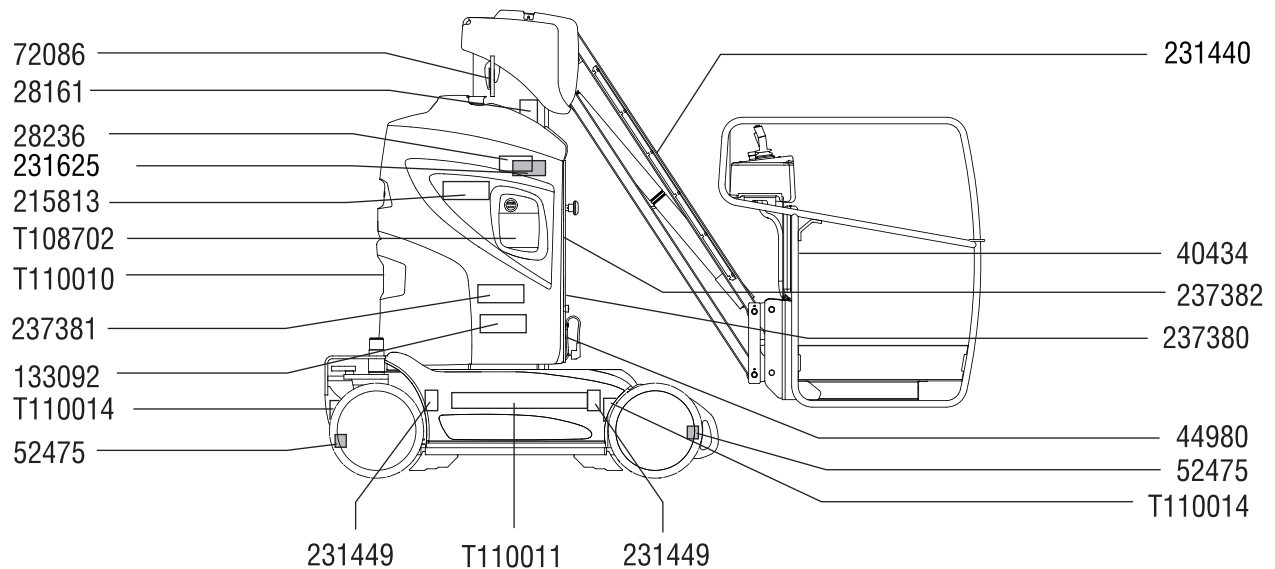
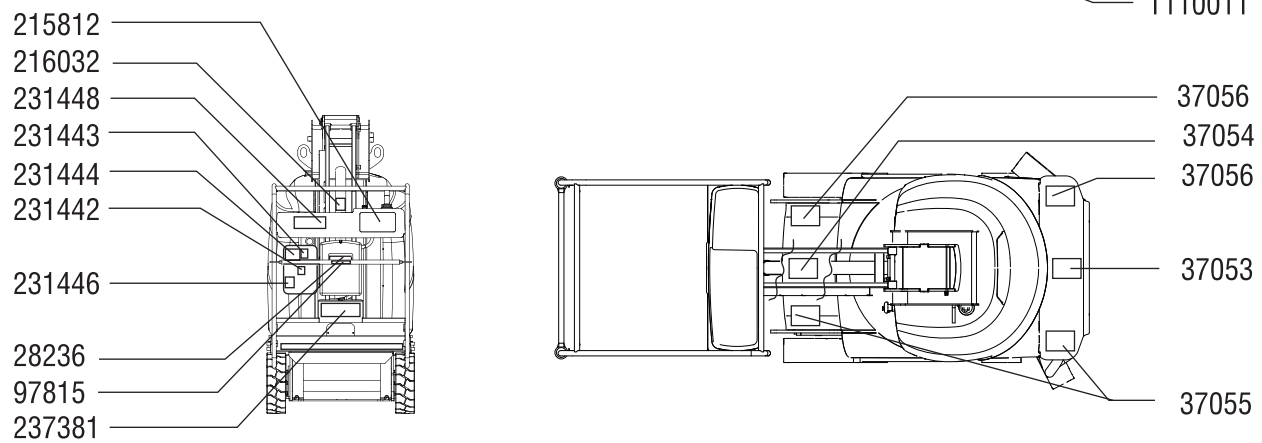
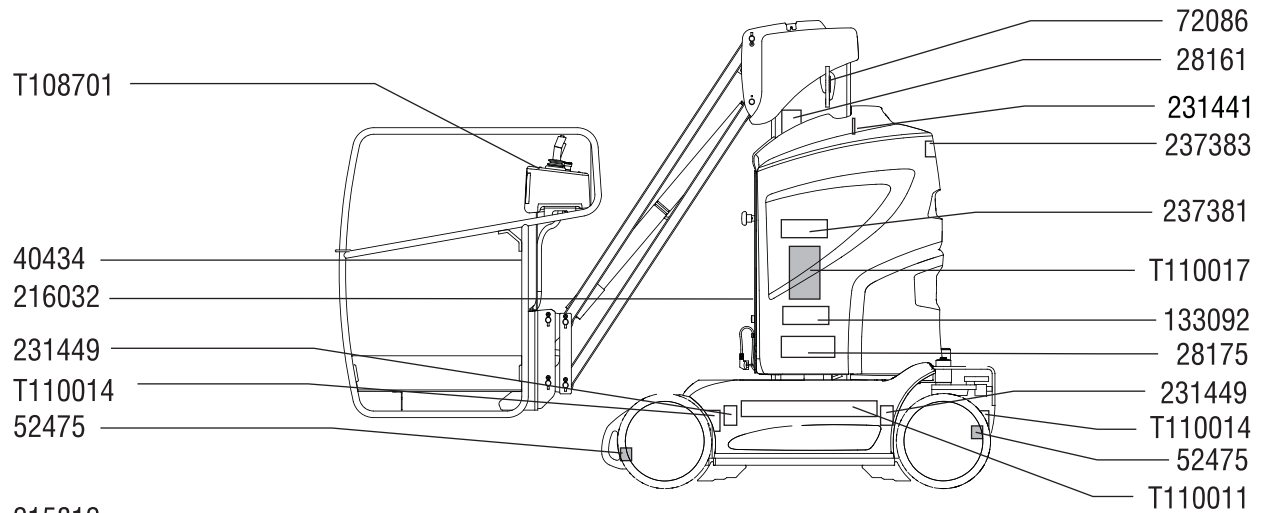

Inspections

Inspection for Decals with Symbols

Determine whether the decals on your machine have words or symbols. Use the appropriate inspection to verify that all decals are legible and in place.

Part No.	Decal Description	Quantity
37053	Arrow - Blue	1
37054	Arrow - Yellow	1
37055	Triangle - Blue	2
37056	Triangle - Yellow	2
40434	Label - Lanyard Anchorage	2
44980	Label - Power to Charger, 115V	1
52475	Label - Transport Tie-down	4
72086	Label - Lifting Eye	2
82472	Label - Crushing Hazard	2
82473	Warning - Compartment Access	1
82481	Label - Battery Safety	1
82487	Label - Read the Manual	2
82614	Label - Collision Hazard	1
97815	Label - Lower Mid-rail	1
97899	Label - Safety Chock	2
114334	Label - Electrocution Hazard, AC Power Supply	1
133015	Label - Electrocution Hazard	3
216032	Label - Power to Platform, 115V	2
216141	Label - Maximum Capacity, Wind Speed	1
216142	Label - Tip-over Hazard, Slope	1
216143	Label - Runaway Machine Hazard	1

Part No.	Decal Description	Quantity
216144	Label - Collision Hazard	1
216145	Label - Drive Direction Hazard	1
T108701	Platform Control Panel	1
T108702	Ground Control Panel	1
T110010	Cosmetic - Genie	1
T110011	Cosmetic - Genie GR-26J	2
T110014	Label - Wheel Load	4
T110015	Label - Fall Hazard	1
T110016	Label - Tilt Alarm	1
T110017	Label - Emergency Lowering	1
T110018	Label - Brake Release Safety & Operation	1
T110021	Label - Tip-over Hazard, Batteries	1

Inspections

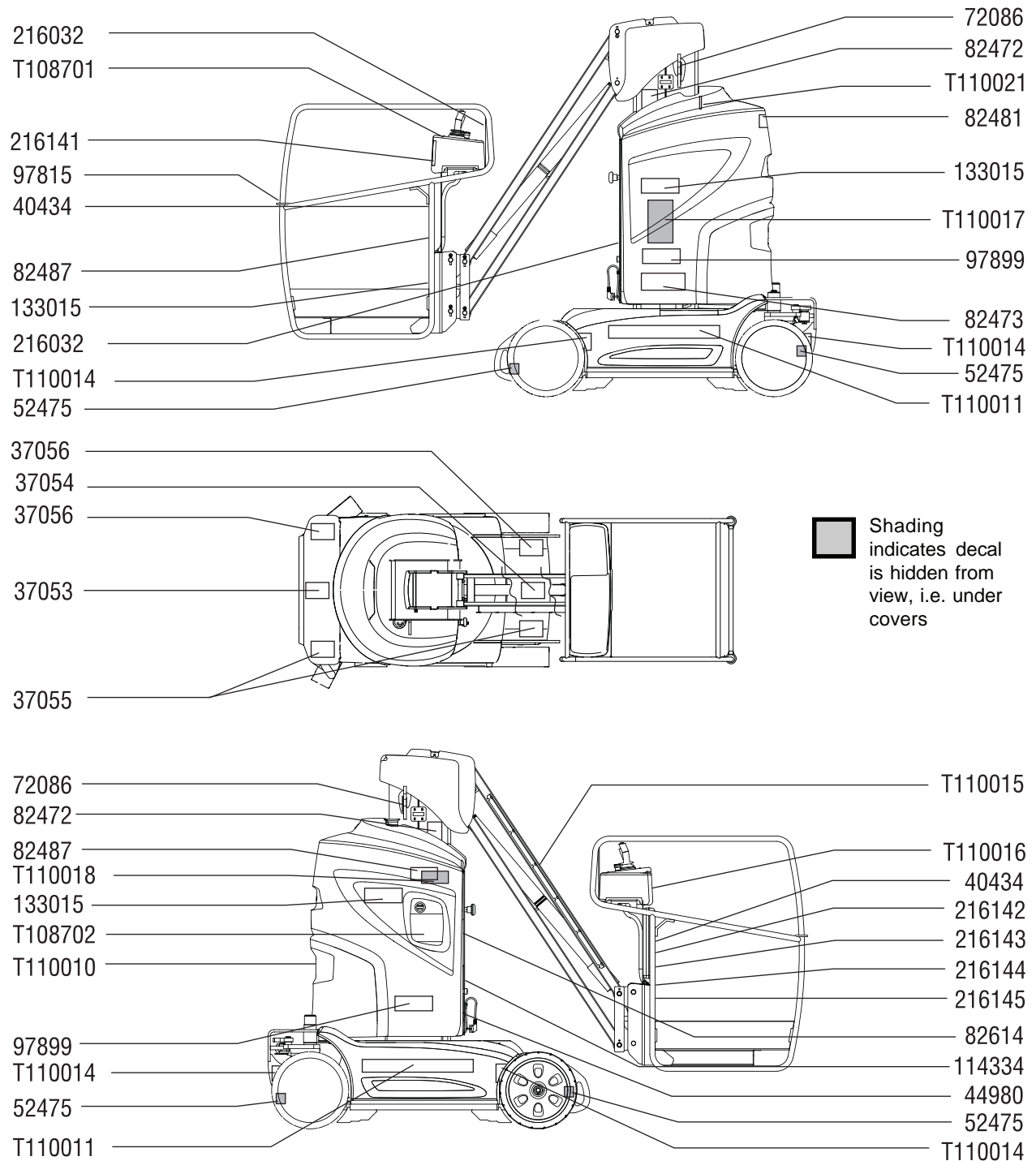

Operating Instructions



Do Not Operate Unless:

- You learn and practice the principles of safe machine operation contained in this operator's manual.
 - 1 Avoid hazardous situations.
 - 2 Always perform a pre-operation inspection.
 - 3 Always perform function tests prior to use.
 - 4 Inspect the workplace.
 - 5 Only use the machine as it was intended.**

Fundamentals

The Operating Instructions section provides instructions for each aspect of machine operation. It is the operator's responsibility to follow all the safety rules and instructions in the operator's, safety and responsibilities manuals.

Using the machine for anything other than lifting personnel, along with their tools and materials, to an aerial work site is unsafe and dangerous.

Only trained and authorized personnel should be permitted to operate a machine. If more than one operator is expected to use a machine at different times in the same work shift, they must all be qualified operators and are all expected to follow all safety rules and instructions in the operator's, safety and responsibilities manuals. That means every new operator should perform a pre-operation inspection, function tests, and a workplace inspection before using the machine.

Operating Instructions

Emergency Stop

Push in either red Emergency Stop button to the off position to stop all machine functions.

Repair any function that operates when the red Emergency Stop button is pushed in.

Selecting and operating the ground controls will override the platform red Emergency Stop button.

Emergency Lowering

To Lower the Mast

- 1 Open the turntable cover opposite the ground controls.
- 2 Locate the mast function valve on the function manifold.

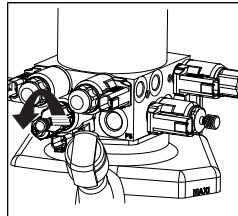

- 3 Turn the cap counterclockwise to open the valve.
- 4 Open the turntable cover on the ground controls side.
- 5 Locate the emergency lowering button.
- 6 Push and hold the emergency lowering button.
- 7 Turn the cap on the valve clockwise to close the valve.

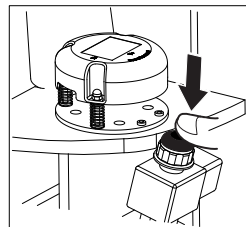

To Rotate the Turntable

- 1 Open the turntable cover opposite the ground controls.
- 2 Locate the valve on the side of the manifold used for manually operating functions.

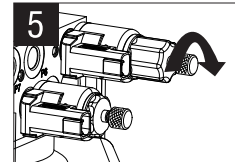

- 3 Turn the cap on the valve. Turn the cap counterclockwise for turntable rotate right. Turn the cap clockwise for turntable rotate left.

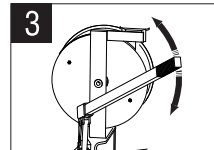

- 4 Insert the manual hand pump handle into the pump.

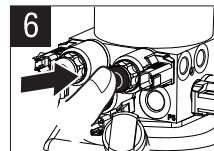

- 5 Locate the turntable rotate valve on the manifold. Push and hold the black button on the end of the valve.
- 6 While holding the black button, pump the handle up and down.
- 7 Turn the valve on the manifold all the way in the counterclockwise direction to reset the valve.

Operating Instructions

To Lower the Jib Boom

1 Lower the mast using the Emergency Lowering procedure To Lower the Mast.

2 Locate the valve on the jib boom.

3 Turn the cap on the jib boom valve counterclockwise, to open the valve.

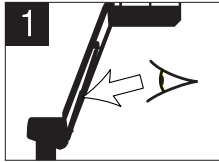

4 Open the turntable cover opposite the ground controls.

5 Locate the valve on the side of the manifold used for manually operating functions.

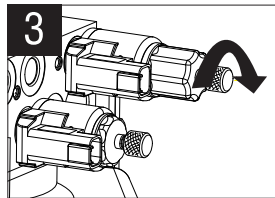

6 Slowly turn the cap on the valve clockwise.

⦿ Result: The jib boom will lower when the valve is turned to the center of the range of motion.

7 When the jib boom is lowered, turn the cap on the jib boom valve clockwise to close the valve.

8 At the manifold used for manually operating functions, turn the valve cap counterclockwise to close the valve.

To Steer

1 Open the turntable cover opposite the ground controls.

2 Locate the steer valve on the function manifold. Push and hold the black button on the end of the valve.

3 Insert the manual hand pump handle into the pump and pump the handle up and down.

⦿ Result: The tires turn to the right.

4 Locate the valve on the function manifold used for manually operating functions.

5 Turn the cap on the valve counterclockwise.

6 Locate the steer valve on the function manifold. Push and hold the black button on the end of the valve.

7 Insert the manual hand pump handle into the pump and pump the handle up and down.

⦿ Result: The tires turn to the left.

8 The manual hand pump handle is stored under the chassis covers in front of the batteries.

Operation from Ground

1 Turn the key switch to ground control.

2 Pull out the red Emergency Stop button to the on position.

To Position Platform

1 Push and hold the appropriate function button.

2 Press and hold the appropriate function enable button.

Drive and steer functions are not available from the ground controls.

Operating Instructions

Operation from Platform

- 1 Turn the key switch to platform control.
- 2 Pull out the ground red Emergency Stop button to the on position. Twist to release the platform red Emergency Stop button to the on position.

To Position Platform

- 1 Press a function select button. The indicator light next to the selected function will be on.
If the control handle is not moved within 5 seconds of selecting a function, the function will not operate. Select the function again.
- 2 Press and hold the function enable switch on the control handle.
- 3 Move the control handle in the direction indicated by the markings on the control panel.

To Steer

- 1 Press the drive function select button. The indicator light next to the drive function will be on.
If the control handle is not moved within 5 seconds of selecting a function, the function will not operate. Select the function again.
- 2 Press and hold the function enable switch on the control handle.
- 3 Press the thumb rocker switch on the top of the control handle.

Use the color-coded direction triangles on the platform controls and the drive chassis to identify the direction the wheels will turn.

To Drive

- 1 Press the drive function select button. The indicator light next to the drive function will be on.

If the control handle is not moved within 5 seconds of selecting a function, the function will not operate. Select the function again.

- 2 Press and hold the function enable switch on the control handle.
- 2 Increase speed: Slowly move the drive control handle off center.
Decrease speed: Slowly move the drive control handle toward center.
Stop: Return the drive control handle to center or release the function enable switch.

Use the color-coded direction arrows on the platform controls and the drive chassis to identify the direction the machine will travel.

Machine travel speed is restricted when the mast or jib boom is raised.

Operating Instructions

Drive Enable

Light on indicates that the boom has moved just past either non-steer wheel and drive function has been interrupted.



Push and hold the drive enable button and then push the drive select function. The green indicator light should come on.

To drive, slowly move the drive control handle off center.

Be aware that the machine may move in the opposite direction that the drive and steer controls are moved.

Always use the color-coded direction arrows on the platform controls and the drive chassis to identify the direction the machine will travel.

If the control handle is not moved within 5 seconds of selecting a function, the function will not operate. Select the function again.

Machine Not Level Indicator Light



Light flashing indicates the machine is not level. The tilt alarm will be sounding when this light is flashing. Move the machine to a firm level surface.

Operating Instructions

▲ Driving on a Slope

Determine the slope and side slope ratings for the machine and determine the slope grade.

Maximum slope rating, : 25% (14°)

Maximum side slope rating: 15% (9°)

Note: Slope rating is subject to ground conditions and adequate traction.

Be sure the platform is lowered and the platform is between the non-steer wheels.

To determine the slope grade:

Measure the slope with a digital inclinometer OR use the following procedure.

You will need:

carpenter's level

straight piece of wood, at least 1 m long

tape measure

Lay the piece of wood on the slope.

At the downhill end, lay the level on the top edge of the piece of wood and lift the end until the piece of wood is level.

While holding the piece of wood level, measure the vertical distance from the bottom of the piece of wood to the ground.

Divide the tape measure distance (rise) by the length of the piece of wood (run) and multiply by 100.

Example:



Piece of wood = 144 inches (3.6 m)

Run = 144 inches (3.6 m)

Rise = 12 inches (0.3 m)

$12 \text{ in} \div 144 \text{ in} = 0.083 \times 100 = 8.3\% \text{ grade}$

$0.3 \text{ m} \div 3.6 \text{ m} = 0.083 \times 100 = 8.3\% \text{ grade}$

If the slope exceeds the maximum uphill, downhill or side slope rating, then the machine must be winched or transported up or down the slope. See Transport and Lifting section.

Operating Instructions



Battery and Charger Instructions

Observe and Obey:

- Do not use an external charger or booster battery.
- Charge the battery in a well-ventilated area.
- Use proper AC input voltage for charging as indicated on the charger.
- Use only Genie authorized battery and charger.

To Charge Battery

- 1 Open the turntable covers. The covers should remain open for the entire charging cycle.
- 2 Push in the red Emergency Stop button on the turntable.
- 3 Remove the battery vent caps and check the battery electrolyte level. If necessary, add distilled water to reach a level of 0.4 in / 1 cm above the plates in each battery cell. Do not overfill.

Do not charge the batteries if the battery electrolyte temperature is above 104° F / 40° C. Let the electrolyte temperature cool down first before charging the batteries.

- 4 Clean and replace the battery vent caps.
- 5 Connect the battery charger to a grounded AC power supply. Once the charging cycle begins, do not interrupt. A charge cycle of approximately 10 hours will be required for batteries discharged 70% to 80%.
- 6 The charger will indicate when the battery is fully charged.
- 7 Remove the battery vent caps and check the battery electrolyte level when the charging cycle is complete. Replenish with distilled water to reach a level of 0.4 in / 1 cm above the plates in each cell. Do not overfill.
- 8 Replace the battery vent caps.
- 9 Disconnect the charger from the AC power supply.
- 10 Close the battery covers and latch.
- 11 Pull out the red Emergency Stop button to the on position.

Operating Instructions

Dry Battery Filling and Charging Instructions

- 1 Open the turntable covers. The covers should remain open for the entire charging cycle.
- 2 Remove the battery vent caps and permanently remove the plastic seal from the battery vent openings.
- 3 Fill each cell with battery electrolyte until the level is sufficient to cover the plates.

Do not fill to maximum level until the battery charge cycle is complete. Overfilling can cause the battery electrolyte to overflow during charging. Neutralize battery electrolyte spills with baking soda and water.

- 4 Install the battery vent caps.
- 5 Push in the red Emergency Stop button.
- 6 Connect the battery charger to a grounded AC power supply. Once the charging cycle begins, do not interrupt.
- 7 The charger will indicate when the battery is fully charged.
- 8 Remove the battery vent caps and check the battery electrolyte level when the charging cycle is complete. Replenish with distilled water to reach a level of 1 cm above the plates in each cell. Do not overfill.

Transport and Lifting Instructions



Observe and Obey:

- ☑ Genie Industries provides this securement information as a recommendation. Drivers are solely responsible for making sure machines are properly secured and the correct trailer is selected pursuant to US Department of Transportation regulations, other localized regulations, and their company policy.
- ☑ Genie customers needing to containerize any lift or Genie product should source a qualified freight forwarder with expertise in preparing, loading and securing construction and lifting equipment for international shipment.
- ☑ Only qualified aerial lift operators should move the machine on or off the truck.
- ☑ The transport vehicle must be parked on a level surface.
- ☑ The transport vehicle must be secured to prevent rolling while the machine is being loaded.
- ☑ Be sure the vehicle capacity, loading surfaces and chains or straps are sufficient to withstand the machine weight. Genie lifts are very heavy relative to their size. See the serial label for the machine weight.
- ☑ Do not drive the machine on a slope that exceeds the slope or side slope rating. See Driving on a Slope in the Operating Instructions section.
- ☑ If the slope of the transport vehicle bed exceeds the maximum slope rating, the machine must be loaded and unloaded using a winch as described. See the Specifications section for the slope ratings.

Brake Release Operation

- 1 Chock the wheels to prevent the machine from rolling.
- 2 Be sure the winch line is properly secured to the drive chassis tie points and the path is clear of all obstructions.
- 3 Locate the brake release toggle switch under the ground controls side turntable cover.
- 4 Move the brake release toggle switch to the left to release the brakes. An alarm will sound and no function will operate.



After the machine is loaded:

- 1 Chock the wheels to prevent the machine from rolling.
- 2 Move the brake release toggle switch to the right to reset the brakes.

Transport and Lifting Instructions

⚠ Securing to Truck or Trailer for Transit

Turn the key switch to the off position and remove the key before transporting.

Inspect the entire machine for loose or unsecured items.

Securing the Chassis

Use chains of ample load capacity.

Use a minimum of 4 chains.

Adjust the rigging to prevent damage to the chains.

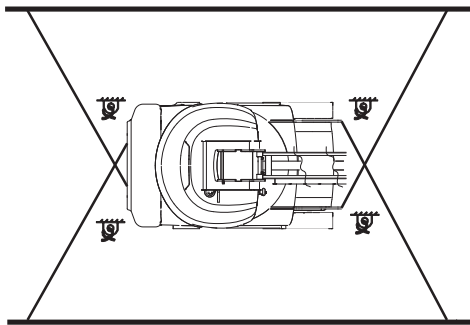

Transport and Lifting Instructions



Observe and Obey:

- ☑ Only qualified riggers should rig and lift the machine.
- ☑ Be sure the crane capacity, loading surfaces and straps or lines are sufficient to withstand the machine weight. See the serial label for the machine weight.

Lifting Instructions

Fully lower the mast and jib boom. Remove all loose items on the machine.

Attach the rigging only to the designated lifting points on the machine. There are two lifting points on the top of the mast.

Adjust the rigging to prevent damage to the machine and to keep the machine level.

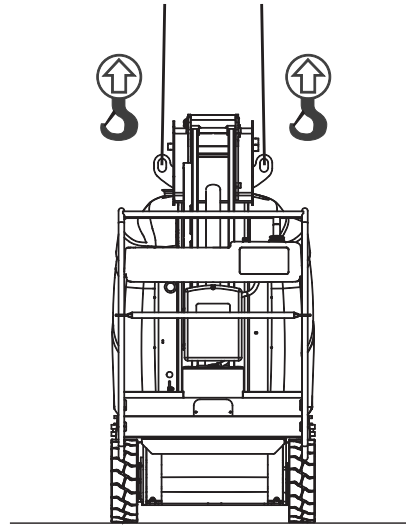

Maintenance



Observe and Obey:

- ☑ Only routine maintenance items specified in this manual shall be performed by the operator.
- ☑ Scheduled maintenance inspections shall be completed by qualified service technicians, according to the manufacturer's specifications and the requirements specified in the responsibilities manual.
- ☑ Use only Genie approved replacement parts.

Maintenance Symbols Legend

The following symbols have been used in this manual to help communicate the intent of the instructions. When one or more of the symbols appear at the beginning of a maintenance procedure, it conveys the meaning below.



Indicates that tools will be required to perform this procedure.



Indicates that new parts will be required to perform this procedure.



Indicates that a cold motor or pump will be required to perform this procedure.

Check the Batteries



Proper battery condition is essential to good machine performance and operational safety. Improper fluid levels or damaged cables and connections can result in component damage and hazardous conditions.

⚠ Electrocutation hazard. Contact with hot or live circuits may result in death or serious injury. Remove all rings, watches and other jewelry.

⚠ Bodily injury hazard. Batteries contain acid. Avoid spilling or contacting battery acid. Neutralize battery acid spills with baking soda and water.

- 1 Put on protective clothing and eye wear.
- 2 Be sure that the battery cable connections are tight and free of corrosion.
- 3 Be sure that the battery hold-down brackets are in place and secure.

Note: Adding terminal protectors and a corrosion preventative sealant will help eliminate corrosion on the battery terminals and cables.

Maintenance

Check the Hydraulic Oil Level



Maintaining the hydraulic oil at the proper level is essential to machine operation. Improper hydraulic oil levels can damage hydraulic components. Daily checks allow the inspector to identify changes in oil level that might indicate the presence of hydraulic system problems.

- 1 Be sure that the boom is in the stowed position, then visually inspect the sight gauge located on the side of the hydraulic oil tank. Add oil as needed.
- ⊙ Result: The hydraulic oil level should be at the FULL mark on the side of the hydraulic tank.

Hydraulic oil specifications

Hydraulic oil type	Chevron Rando HD equivalent
--------------------	-----------------------------

Scheduled Maintenance

Maintenance performed quarterly, annually and every two years must be completed by a person trained and qualified to perform maintenance on this machine according to the procedures found in the service manual for this machine.

Machines that have been out of service for more than three months must receive the quarterly inspection before they are put back into service.

Specifications

Model		GR-26J
Height, working maximum	31 ft 11 in	9.7 m
Height, platform maximum	25 ft 11 in	7.9 m
Height, stowed maximum	78 in	1.99 m
Horizontal reach maximum	8 ft 3 in	2.51 m
Width	44.8 in	1.14 m
Length, stowed	109 in	2.76 m
Maximum load capacity	500 lbs	227kg
Maximum wind speed	28 mph	12.5 m/s
Wheelbase	47 in	1.2 m
Turning radius (inside)	31 in	0.78 m
Turning radius (outside)	92 in	2.3 m
Turntable rotation		350°
Turntable tailswing	1 in	2.5 cm
Power source	12 2V, 280 AH batteries	
Drive speed, stowed	2.8 mph	4.5 km/h 12.2 m/9.7 sec
Drive speed, booms raised	0.4 mph	0.65 km/h 12.2 m/67 sec
Vibration value does not exceed 2.5 m/s ²		
Ground clearance	3.4 in	8.5 cm
Weight	6250 lbs	2835kg
(Machine weights vary with option configurations. See serial label for specific machine weight.)		
Airborne noise emissions		
Sound pressure level at ground workstation	<70 dBA	
Sound pressure level at platform workstation	<70 dBA	

Platform dimensions (length x width)	30 in x 35 in 75 cm x 90 cm
Platform leveling	self-leveling
Turntable rotation	350°
Controls	24V DC proportional
AC outlet in platform	standard
Hydraulic pressure (maximum) (boom functions)	140 bar
System voltage	24V
Tire size (non-marking)	16 in x 11 in 40.6 cm x 28 cm

Maximum slope rating, stowed position 25% (14°)

Maximum side slope rating, stowed position 15% (9°)

Note: Slope rating is subject to ground conditions and adequate traction.

Floor loading information

Tire load, maximum	3126 lbs	1418 kg
Occupied floor pressure	390 psf	1895 kg/m ² 18.6 kPa

Note: Floor loading information is approximate and does not incorporate different option configurations. It should be used only with adequate safety factors.

Continuous improvement of our products is a Genie policy.
Product specifications are subject to change without notice or obligation.

Genie Sweden
Phone 0046 3157 5101
Fax 0046 3157 5104

Genie France
Phone 0033 237 260 986
Fax 0033 237 260 998

Genie Iberica
Phone 0034 900 808 110
Fax 0034 935 725 080

Genie Germany
Phone 0800 180 9017
Phone 0049 4221 491 821
Fax 0049 4221 491 820

Genie U.K.
Phone 0044 1476 584 333
Fax 0044 1476 584 330

Genie Mexico City
Phone +52 55 5666 5242
Fax +52 55 5666 3241

Genie North America
Phone 425.881.1800
Toll Free USA and Canada
800.536.1800
Fax 425.883.3475

Genie Australia Pty Ltd.
Phone +61 7 3375 1660
Fax +61 7 3375 1002

Genie China
Phone +86 21 53853768
Fax +86 21 53852569

Genie Singapore
Phone +65 67533544
Fax +65 67533544

Genie Japan
Phone +81 3 6436 2020
Fax +81 3 5445 1231

Genie Korea
Phone +82 2 558 7267
Fax +82 2 558 3910

Genie Brasil
Phone +55 11 4082 5600
Fax +55 22 4082 5630

Genie Holland
Phone +31 183 581 102
Fax +31 183 581 566

Distributed By: